

Assessing boat waste impacts on small wastewater treatment plant operations

Jennifer Kersh

A thesis  
submitted in partial fulfillment of the  
requirements for the degree of

Master of Science in Civil Engineering

University of Washington  
2018

Committee:

Heidi L. Gough, Committee Chair

Michael Brett

C. Andrew James

Program Authorized to Offer Degree:  
Civil and Environmental Engineering

©Copyright 2018  
Jennifer Kersh

University of Washington

Abstract

Assessing boat waste impacts on small wastewater treatment plant operations

Jennifer Kersh

Chair of the Supervisory Committee:  
Dr. Heidi Gough  
School of Environmental and Forest Sciences

With implementation of the Clean Vessel Act Wastewater Project it is imperative to understand potential impacts of recreational boat waste on wastewater treatment plant operations. The Clean Vessel Act funds the creation of pumpout stations (similar to RV dump stations) to provide alternatives to disposal of recreational boat waste overboard (U.S. Fish and Wildlife Service). Boat waste is black water (water from toilets) from recreational boats that is pumped into on-shore pumpout tanks. In the past, this waste was often discharged directly into the surrounding water. As more boat waste is diverted from direct disposal, wastewater treatment plants located near pumpout facilities are often asked to accept this additional influent. Since many boating activities take place in remote areas, many potentially impacted treatment facilities are small (<0.1 million gallons per day, MGD). Thus, recreational boat waste may have a substantial impact to their operations. Characterizing and analyzing impacts of boat waste to these small facilities is an imperative first step to the successful treatment of this increasing wastewater source.

This study presents results from a suite of tests which provide important measures of potential effects of boat waste on treatment processes. Testing was conducted to characterize boat waste

and activated sludge from the Salish Sea (San Juan Islands and Puget Sound, Washington). Direct effects of shock-loading boat waste to activated sludge were additionally measured. Characterization revealed boat waste constituents were substantially more concentrated than typical raw wastewater. On average boat waste contained 60× the ammonia, 10× the COD, 20× the reactive phosphorus, 15× the salinity, and 7× the total suspended solids (TSS) of typical untreated domestic wastewater. Constituent concentrations in boat waste and activate sludge samples varied among sample locations and dates and resulted in varying impacts by boat waste on activated sludge properties. Increases in oxygen uptake rate, settling ability, and foaming were observed as boat waste was added to activated sludge at volumes of up to 10%. Furthermore, separate addition of a holding tank deodorant increased foaming in activated sludge samples.

These results will interest wastewater treatment plant operators when making decisions about either accepting boat waste or designing for treatment of this increasing wastewater source.

## Table of Contents

Table of Contents .....	5
List of Figures .....	8
List of Tables .....	9
Acknowledgements.....	10
Introduction.....	11
Scope of Work .....	13
Background.....	15
Literature Review.....	16
Characteristics of Boat Waste.....	23
Boat Waste Additives .....	24
Salinity .....	25
Petroleum .....	26
Methods.....	28
Sample Collection and Storage.....	28
Characterization of Wastes .....	28
Chemical Profiling Analysis .....	29
Impact of Boat Waste on Activated Sludge.....	30
Specific Oxygen Uptake Rate.....	31
COD Degradation .....	31

Nitrogen Conversion.....	32
Settleability .....	33
Foaming .....	33
Data Analysis .....	33
Results.....	35
Wastewater Treatment Plant Operator Interviews .....	35
Survey of Boat Waste Additives.....	36
Characterization of Wastes .....	37
Chemical Profiling of Boat Waste and Additives .....	40
Impact of Boat Waste on Microbial Activity.....	44
Specific Oxygen Uptake Rate.....	44
COD Degradation .....	47
Nitrogen Conversion.....	48
Impacts of Boat Waste on Activated Sludge Physical Responses .....	50
Settleability .....	50
Foaming .....	51
Boat Waste Component Impact .....	53
Discussion.....	54
Conclusions and Recommendations .....	60
References.....	62

Appendix A. San Juan Island Treatment Plant Process Flow Diagrams. ....	70
Appendix B. Sampling Events and Tests Performed. ....	73
Appendix C. Oxygen Uptake Measurements for SOUR Calculations. ....	75
Appendix D. Non-Normalized SOUR and SVI Results and Impacts of Boat Waste Components on Activated Sludge Behavior. ....	79

## List of Figures

Figure 1. Activated Sludge Process Flow Diagram. ....	16
Figure 2. Thetford Marine Aqua-Kem Holding Tank Deodorant.....	25
Figure 3. Unique and Concurrent Features for Boat Waste and Additives. ....	41
Figure 3a. Unique and Concurrent Features for Three Boat Waste Additives. ....	41
Figure 4. Unique and Concurrent Features for Boat Waste Solid and Liquid.....	43
Figure 5. Example Oxygen Uptake During SOUR Trials. ....	45
Figure 6. SOURs of boat waste and activated sludge mixtures.....	46
Figure 7. COD degradation constants of boat waste and activated sludge mixtures.....	47
Figure 8. Nitrogen Species in Aerated Activated Sludge. ....	49
Figure 9. Nitrogen Species in an Aerated Boat Waste (10%) and Activated Sludge Mixture. ....	50
Figure 10. SVI of boat waste and activated sludge mixtures.....	51
Figure 11. Foaming in boat waste and activated sludge mixtures. ....	53



## List of Tables

Table 1. Search Results for Relevant Search Terms. ....	18
Table 2. Reported Boat Waste Characteristics. ....	24
Table 3. Effects of Petroleum on Wastewater Treatment Processes. ....	27
Table 4. San Juan Island Treatment Plant Operator Concerns. ....	36
Table 5. Chemical Composition of Purchasable Boat Waste Additives. ....	37
Table 6. Characterization of Waste Components. ....	39
Table 7. Solids Characterization of Waste Components. ....	40
Table 8. Compounds Present in Boat Waste and All Boat Waste Additives. ....	44
Table 9. Direction of Observed Impacts of Salt and Boat Waste Deodorant on Activated Sludge. .....	54
Table 10. Summary of Impact Testing Results. ....	60

## **Acknowledgements**

I would like to thank my advisor, Dr. Heidi Gough, for her support and expertise on the subject. Funding was provided by Washington Sea Grant and Washington State Parks. Aaron Barnett, Bridget Trosin, Al Wolslegel, and Catherine Buchalski-Smith organized San Juan Island research visits and provided valuable insights on Clean Vessel Act challenges specific to San Juan County. Andy James from the Center for Urban Waters University of Washington Laboratories provided instruction and lab space for chemical profiling analysis along with researchers Alex Gipe, Zhenyu Tian, and Katherine Peter. The environmental biotechnology group (Yash Chaudhary, Khaled Salam, Amber Longrie, Benjamin Therrien, Margot Amitrano, Elizabeth Guilford, Keenan Ferar, and Sterling Bath) assisted with experiments and provided project feedback. Operators and staff at Friday Harbor, Eastsound, and Fisherman's Bay Wastewater Treatment Plants assisted with sample collection and shared knowledge and experiences. King County staff Teresa Allen, Bob Bucher, and others assisted with sample collection and treatment questions. Terry and Sons Mobile Pumpout and the Port of Friday Harbor staff assisted with recreational boat waste sampling. Environmental lab staff Sean Yeung and Songlin Wang helped with equipment orders and frequent lab supply questions. Engineering librarian Julie Cook was an invaluable resource for literature review. Finally, UW Friday Harbor Labs provided lab space during the summer of 2017 and 2018.

## Introduction

Non-municipal wastewater streams can pose a potential challenge to wastewater treatment plant operations. Specifically, streams that contain constituent concentrations outside the typical range can impact overall influent parameters even with small loadings (Tchobanoglous et al. 2014). This is particularly important in small wastewater treatment operations for which side-streams might constitute a significant portion of influent. Among the side-streams of potential relevance to small wastewater treatment plants is toilet waste from recreational boats (i.e. “boat waste”). There is a current trend to decrease direct discharge of boat waste in order to improve water quality in marine waters (Sea Grant Washington 2016). To achieve decreased discharge, wastewater treatment facilities nearest to marina pumpout stations are being asked to accept this side-stream influent. Many marinas are located substantial distances from large wastewater treatment facilities. A thorough understanding of boat waste and its impact on plant operations is critical to achieving successful treatment.

Recreational boat waste contains high levels of biological oxygen demand (BOD), chemical oxygen demand (COD), solids, and nitrogen compared to typical raw wastewater (Robins and Green 1974, Watson 2005, Oregon State Marine Board 1995). High strength waste (waste containing elevated constituent concentrations) is produced routinely from industrial and chemical applications and is notoriously difficult to treat, especially using biological methods such as activated sludge (Hamza et al. 2016). Recent research has focused on the improvement of activated sludge processes in treating these high strength wastes. Research approaches include process modeling to optimize operating conditions (Elawwad 2018), use of extended aeration activated sludge (EAAS) (Gholami et al. 2011), and addition of microalgae and LED lights to the

activated sludge process (Tsiptsias et al. 2016). However, research dealing with biological treatment of recreational boat waste specifically, is lacking.

Among concerns for recreational boat waste are chemicals that disrupt microbial activity.

Deodorants and other additives are marketed to recreational boaters to reduce on-board odors.

Synthetic organic chemicals such as those found in boat waste additives are sometimes difficult to biodegrade in activated sludge treatment and can be toxic to sludge microorganisms without proper acclimation (Tchobanoglous et al. 2014). In the past, additives have been linked to potential declines in activated sludge performance (Robins and Green 1974, Walker et al. 1991, Oregon State Marine Board 1995, Thomas 2002). Formaldehyde has been among the most highly reported of inhibitory agents (Robins and Green 1974). However, formaldehyde has been phased out of use and replaced; the impact of newer products remains unclear.

In this study, the impacts of boat waste on activated sludge microbial communities, settling ability, foaming, and nitrification were studied. The study focused on two wastewater treatment facilities located in San Juan County, Washington State, USA. San Juan County consists of a cluster of islands located in the Salish Sea in the northwest corner of Washington State. Access is limited and requires transportation by ferry, small aircraft, or personal boat. As a result, the islands are a popular destination for recreational boaters, who often use pumpout stations provided at marinas to dispose of holding tank waste. Transportation of this high strength waste to off-island treatment plants via ferry is excessively costly, and information is lacking to allow small wastewater treatment facilities to make decisions about accepting the waste stream.

This study tested the impacts of boat waste on the activated sludge of Island wastewater treatment plants. Biologic activity was evaluated using specific oxygen uptake rate (SOUR), chemical oxygen demand (COD) degradation, and nitrogen conversion tests. Physical characteristics were studied using the sludge volume index (SVI) and foaming tests. Results varied by sampling location and date, however increases in oxygen uptake, foaming, and settling were observed as boat waste was added to activated sludge.

## **Scope of Work**

This thesis describes research for Washington Sea Grant and Washington State Parks and focused on determining potential impacts of boat waste on wastewater treatment facilities, specifically in Friday Harbor and Orcas Island (Eastsound). Evaluation of the Lopez Island wastewater treatment facility was also considered, but as the process differed substantially from the others, direct testing was not conducted. Boat waste is defined as black water (water from toilets containing urine, feces, and flush water) that is contained in recreational vessel holding tanks. Characterization of boat waste included analysis of chemical oxygen demand (COD),  $\text{NH}_4^+$ , pH, salinity, reactive phosphorus, total suspended solids (TSS), volatile suspended solids (VSS), total solids (TS), and total volatile solids (TVS). Bench testing to assess impacts on activated sludge was performed.

The scope of the project included the following:

- Stakeholder meetings – Met five (5) times in person at the Sea Grant building on the UW Seattle campus with Sea Grant Personnel and Washington State Parks representatives.

- Existing literature review – Obtained information on boat waste characterization, seawater impacts, past experiences of wastewater treatment facilities receiving boat waste, and boat waste additives.
- Potentially-impacted wastewater treatment facility tours – Visited Orcas Island (Eastsound), Friday Harbor, and Lopez Island Wastewater Treatment Plants and communicated with operators to identify concerns with accepting boat waste.
- Boat waste characterization – Obtained samples from Terry and Sons Mobile Pumpout Service (Seattle) and the Port of Friday Harbor and tested ammonia, COD, pH, salinity, solids, and reactive phosphorus concentrations.
- Boat waste additive review – Identified primary additives of concern and obtained SDS sheets for these additives.
- Boat waste impact on activated sludge efficiency – Obtained activated sludge samples from Island facilities or similar facilities in Seattle and performed batch tests by dosing up to 10% boat waste into activated sludge samples.
- Boat waste component impact on activated sludge efficiency – Measured COD degradation and nitrification efficiencies at various boat waste concentrations and performed batch tests analyzing seawater and boat waste additive impacts on sludge performance.
- Chemical characterization of boat waste and selected additives was conducted via high resolution mass spectrometry using a liquid chromatography quadrupole time of flight mass spectrometer (LC-QToF-MS). The objective was to increase our understanding of the persistence of important components of boat waste which might impact wastewater treatment processes.

## Background

Pumpout Washington (Sea Grant Washington 2016), a project funded by Washington Sea Grant, aimed to establish several new pumpout stations located around the San Juan Islands in order to decrease offshore discharges of recreational boat waste. The conceived plan was to divert the collected wastewater to one of three wastewater treatment facilities already located in San Juan Island County. Operators of these wastewater treatment facilities expressed concern about the effects of this new waste stream on facilities operations. The goal of this project was to investigate some of the expressed concerns.

Recognizing impacts on treatment performance requires an understanding of the activated sludge process. Activated sludge is the living biological component of wastewater treatment facilities that is responsible for conversion of the organic wastes (*aka* chemical oxygen demand, COD) to benign by-products. This process is a common treatment approach throughout the world (Tchobanoglous et al. 2014) and is the type of treatment used in the study facilities in San Juan County, Washington. Activated sludge uses microorganisms to help break down or remove waste constituents (Gerardi 2002). After removal of large settleable solids (e.g. sand and large organic particles) during primary clarification, the wastewater stream enters an aeration tank that is used to grow microbial activated sludge. During a second clarification step, the microbes are settled, and most are returned to the aeration tank to optimize bacterial biomass improve the treatment process, as detailed in Figure 1. Activated Sludge Process Flow Diagram

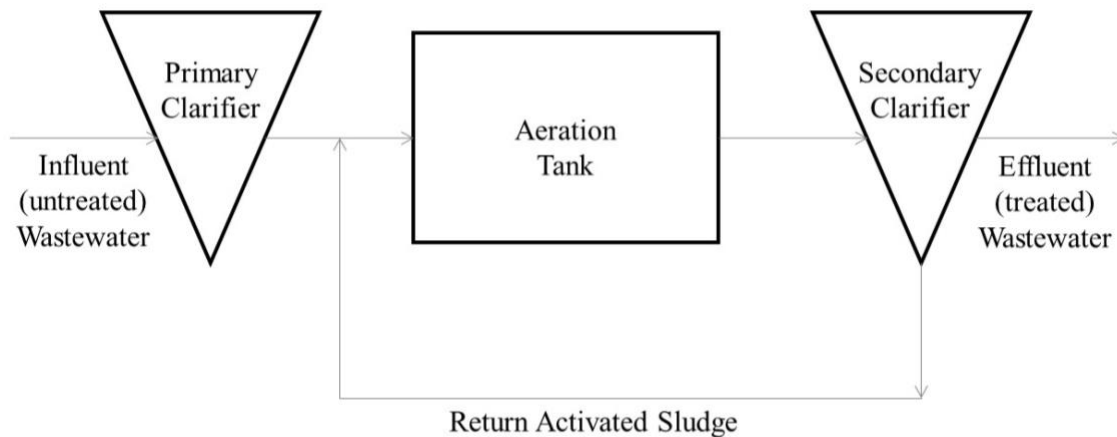

Figure 1. Activated Sludge Process Flow Diagram.

While all three San Juan Island treatment facilities utilized activated sludge, treatment trains varied among the facilities. Eastsound Wastewater Treatment Plant was a secondary-only facility, meaning that wastewater was subjected to primary settling in septic tanks at the point of generation. This makes treatment vulnerable to fluctuations in incoming solids concentration. Friday Harbor Wastewater Treatment Plant included screening and grit removal prior to activated sludge treatment in place of primary settling. Two sequencing batch reactors treated sludge and waste in a batch fashion, cycling five treatment steps: Fill, react, settle, decant, and idle. Process flow diagrams of all three facilities can be found in Appendix A. San Juan Island Treatment Plant Process Flow Diagrams.

## Literature Review

As it was hypothesized available literature concerning the treatment of recreational boat waste was lacking, this study includes a thorough literature review incorporating search methods and article summaries. Relevant research was identified by consulting major online databases using a



variety of applicable search terms. The supposition that little available literature data existed was corroborated by low numbers of records identified by key word searches in major databases (Table 1). Results were further filtered manually upon analysis of the titles and abstracts. Often searches yielding many results contained no research relevant to this project.

The first database consulted was the National Technical Reports Library (NTRL) (<https://ntrl.ntis.gov/NTRL/>), which contains the largest collection of federally-funded technical US government reports. Engineering Village (<https://www.engineeringvillage.com>) combines 12 engineering literature and patent databases that include articles across a wide range of engineering disciplines. The Web of Science was created by the Institute for Scientific Information (ISI) and includes a citation-based search feature. It includes 6 online databases from the Arts and Humanities Citation Index to the Science Citation Index Expanded. The University of Washington Library Search allows users to search all print and electronic items owned by the UW and the Orbis Cascade Alliance (a collection of several schools in Washington, Oregon, and Idaho) as well as 519 literature databases. All databases were consulted in February of 2017.

Table 1. Search Results for Relevant Search Terms.

Search term	Database			
	NTRL	Engineering Village	Web of Science	UW Library Search
“recreational boat” wastewater	1427	1	0	94
“recreational boat waste” characterization	5	0	0	0
“marine waste” characterization	136	7	9	225
"marine waste" disposal	174	21	12	573
“boat waste” characterization	82	0	0	13
“boat waste” treatment of	102	0	1	5
“boat waste” disposal	93	1	0	29
“boat waste” effects of	105	2	2	3

NTRL, National Technical Reports Library

UW, University of Washington

All studies that state effects of boat waste on treatment facilities were published more than 10 years prior to this thesis. This is problematic for two reasons. First, the formulation of boat waste tank additives changed during this time frame. For example, research about the impacts of formaldehyde-containing boat waste additives (Robins and Green 1974, Thomas 2002) was no longer relevant because the use of formaldehyde is no longer common (California 2010). Furthermore, throughout the years, wastewater treatment plants begin to reach their design limitations, so where previously low impacts have been reported, similar loadings could lead to more severe treatment disruptions.

Three (3) government reports, 4 research articles, 2 master's thesis, and 1 PhD dissertation were identified with direct relevance to the current research question. These are summarized below, with an analysis of the relevance of each. These are summarized below, with an analysis of the relevance of each.

1. Oregon State Marine Board (1995). Effects of Boat Waste Disposal at Municipal Wastewater Treatment Facilities.

This article explores the optimal disposal method for recreational boat waste in Oregon State.

The study involved boat waste characterization, an analysis of treatment options available at the time, and a wastewater treatment plant survey. While the report does not include lab studies, the account concludes (from research conducted by others) that boat waste additives are potentially detrimental to treatment processes, and management modifications are recommended. Since this study was relatively recent and conducted nearby, the conclusions are relevant to this project.

2. Novak, J. T., C. R. McDaniel and S. C. Howard (1990). "The effect of boat holding tank chemicals on treatment plant performance." Research Journal of the Water Pollution Control Federation 62(3).

Novak analyzes how odor-control chemicals present in boat waste holding tanks affect the activated sludge process. Three specific odor-control chemicals were (separately) spiked into sludge samples and COD removal, suspended solids discharge, rate of recovery, foaming, and sludge volume were monitored. Novak observed a loss of solids in activated sludge due to foaming caused by additive surfactants. This report provides an example of a lab-based study dealing with influences of boat waste additives on activated sludge, and Novak's research will direct a portion of the lab testing in the present project.

3. Walker, W., C. Haley, P. Bridgeman and S. Goldstein (1991). "Effects of deodorants on treatment of boat holding-tank waste." *Environmental Management* 15(3): 441-449.

This study includes a literature search as well as a survey on RV pumpout stations in Virginia State campgrounds. The goal was to determine if deodorants from holding tanks would have negative effects on marina septic systems or package treatment plants. This report provides an example of a non-lab-based study performed on the influence of boat waste additions to treatment plants. Additives were determined potentially detrimental to activated sludge biology.

4. B. D. Clark (1967). *Houseboat Waste Characteristics and Treatment*. Corvallis, Oregon: U.S. Dept. of the Interior, Federal Water Pollution Control Administration, Northwest Region. Pacific Northwest Water Laboratory.

Many waste characteristics were examined including BOD, COD, TKN (total Kjeldahl nitrogen), total phosphate, total grease and oil, TS, TVS, SS (suspended solids), and VSS. A survey of the features and specifics of the houseboats from which samples were collected is also presented. This study is helpful for reference as it provides a detailed analysis of waste characteristics and because samples were collected from locations pertinent to the project at hand (Oregon and Washington State), but as the study was conducted 60 years ago, chemicals and treatment methods included in the study are likely not representative. Also, houseboat wastes are likely to differ from recreational boat waste due to the presence of on-board equipment such as dishwashers and garbage disposals. High solids and alkalinity levels in houseboat waste were hypothesized to cause problems for aerobic processes.

5. Kiernan, K. E. (1982). An analysis of the potential impacts of recreational vehicle holding tank additives on biological waste treatment, Thesis (M.S.E.) University of Washington.

In a master's thesis study, RV waste was collected from highway rest area dump stations across Washington State. The waste was analyzed for BOD, COD, solids, and additive concentrations, and the impact on municipal wastewater treatment plants is considered. Kiernan concludes that municipal wastewater treatment plants should "suffer no ill effects" from RV waste with additives. This study is relevant as the waste analyzed was from Washington State, but the presence of formaldehyde in the additives dates this study. Furthermore, chemical compositions of RV waste may be significantly different from recreational boat waste.

6. Brown, C. A. (1982). Treatability of recreational vehicle wastewater at highway rest areas, Thesis (M.S.E.) University of Washington.

Like Kiernan's study, RV waste samples were collected from Washington State rest area dump stations. The samples were analyzed for BOD, COD, TSS, VSS, and MLVSS, and the impacts on septic tanks, drain fields, and lagoons were considered. Again, the study is relevant because samples were collected from Washington State, but because the impact is only considered for older treatment technologies the relevance of this project is limited. The waste was determined to be treatable and treatment facility designs were recommended.

7. Thomas, W. (2002). Characterization of the inhibitory effects of recreational vehicle holding tank additive on an activated sludge system. R. J. Murphy, ProQuest Dissertations Publishing. University of South Florida.

This study explores shock loading of additives on aerobic activated sludge systems.

Characteristics considered were COD, reaction order, oxygen uptake rate, nitrification/nitrogen

utilization, and biomass nitrogen. Variables were additive fractions, solid retention times (SRT), and fraction RV wastewater in influent waste. Formaldehyde additives were determined detrimental to treatment effluent quality as well as nitrification in the activated sludge process. This study is a thorough analysis of the potential harm of additives on activated sludge and many treatment characteristics were considered. Furthermore, shock loading procedures are useful for this project. Like several studies, however, the research is dated due to the chemical compositions of tested additives, which have been largely modified over the years.

8. Robins, J. H. and A. C. Green (1974). "Development of On-Shore Treatment Systems for Sewage from Watercraft Waste Retention System." Environmental Protection Technology Series EPA 670/2-74-056.

The effect of recreational watercraft on treatment systems is considered as well as the development of a pilot scale treatment plant. Suspended solids content, BOD, oxygen uptake rate, coliform, COD, phosphates, and nitrogen concentrations were considered as well as effects of formaldehyde, zinc, and quaternary ammonium additives. The relevance of this study is dated due to the content of the additives tested.

9. Watson, J. T. (2005). "Tennessee valley marina and campground wastewater characterization screening study." Proceedings of the Water Environment Federation 2005(12): 3685-3712.

Williams, A. C. (2007). "Tennessee valley marina and campground wastewater characterization screening study follow-up report." Proceedings of the Water Environment Federation 2007(10): 7823-7837.

Pumpout wastewaters were tested for toxicity, pH, nutrients, BOD, and COD. Pumpout waste was determined to be highly concentrated, but upon inspection of treatment effluents, systems

were determined to be adequate for the required treatment levels. Because this study is more recent than many and is conducted at a running facility, conclusions are relevant to this project.

### **Boat Waste Impacts to Treatment Facilities**

To summarize the most significant findings, Clark (1967) concluded that alkalinity of boat wastes may be insufficient to be treated aerobically and Novak et al. (1990) found solids removal was adversely affected by surfactants in additives due to foaming. Furthermore, as demonstrated in Table 2, a few studies observed abnormally high COD levels in boat waste (Clark 1967, Kiernan 1982, Watson 2005) but none found that this was harmful to wastewater treatment processes.

#### *Characteristics of Boat Waste*

Table 2 includes ranges of reported values for several wastewater characteristics and provides a comparison to typical municipal sewage. Boat waste was about ten-fold more concentrated in BOD, COD, and TSS and 20 times more concentrated in TKN when compared to municipal sewage. This indicates boat waste will likely have a significant effect on treatment operations relative to volumes present in influent streams. Furthermore, most treatment facilities are designed to accept waste containing BOD, COD, and solids, but small treatment operations (for example in the San Juan Islands) are often not designed to remove nitrogen.

Table 2. Reported Boat Waste Characteristics.

Parameter	Boat Waste	Municipal Sewage
Chemical Oxygen Demand (COD, mg/L)	1500 to 8000	250 to 800
Biological Oxygen Demand (BOD, mg/L)*	260 to 3000	110 to 350
Total Suspended Solids (TSS, mg/L)	1400 to 2900	120 to 370
Volatile Suspended Solids (VSS, mg/L)	1600 to 2300	95 to 315
Total Kjeldahl Nitrogen (TKN, mg/L)	240 to 1850	20 to 45
References	(Watson 2005, Robins and Green 1974, Oregon State 1995)	(Tchobanoglous et al. 2003, Asano 2007)

\*In untreated waste the BOD/COD ratio is typically 0.3-0.8 (Tchobanoglous 2014).

### *Boat Waste Additives*

Boat waste additives have been reported as potentially detrimental to wastewater processes. (Robins and Green 1974, Novak et al. 1990, Walker et al. 1991, Oregon State Marine Board 1995, Thomas 2002). As manufacturers modify additive ingredients over time, it is important to consider which specific chemicals led to observed effects on treatment. Formaldehyde was the most commonly tested additive chemical. Other chemicals tested were zinc and quaternary ammonium (Robins and Green 1974) as well as various surfactants (Novak et al. 1990). Zinc was determined to adversely affect activated sludge removal efficiency at concentrations of  $\geq 20$  mg/L and formaldehyde at  $\geq 120$  mg/L. Surfactants were linked to an increase in foaming which resulted in a loss of solids in activated sludge. An example 2017 consumer additive product is displayed in Figure 2:





Figure 2. Thetford Marine Aqua-Kem Holding Tank Deodorant.

### *Salinity*

Salinity may have adverse effects on activated sludge processes (Linarić et al. 2013). High salinity waste may enter wastewater treatment plants due to storm surge flooding or as boaters flush their system with seawater. The detriments of high salinity waste have been discovered by analyzing sludge respiration, pH, dissolved oxygen (DO), TSS, VSS, SVI, nitrogen concentrations, phosphate removal, and enzymatic activity. Perneti and DiPalma (2005) observed a respiration inhibition of 4-84% when sludge was shock-loaded with high salinity waste (0.37 to 30.7 g salt/g VSS) and an 81% respiration inhibition when sludge was continuously subjected to high salinity waste (35.5 g salt/g VSS). Linarić, Markić, and Sipos (2013) concluded the microbial activity of activated sludge processes could be sharply reduced due to storm surge flooding at 30 to 40 parts per thousand. Finally, Pronk et al. (2014) discovered high salinity waste severely affected nitrite oxidation, and phosphate removal began to decline at sodium chloride concentrations of 20 parts per thousand. In a sequencing batch reactor, the specific oxygen uptake rate of activated sludge (an indicator of biological activity) was shown to decrease dramatically when salinity was increased from 10 to 30 parts per

thousand (Zhang et al. 2017). This conclusion was supported by Chen et al. (2018), who found the richness and diversity of microbial activity was altered significantly at salinity concentrations of 20 parts per thousand.

### *Petroleum*

Table 3 summarizes findings from studies dealing with effects of petroleum on treatment systems. At the Lopez Island wastewater treatment facility, there is concern with treating boat waste from pumpout stations due to the potential presence of petroleum. Treatment plant operators noted petroleum can enter boat bilges when spilled during fueling. There have been no studies that dealt specifically with the treatment of petroleum from recreational boats, however some research has focused on the treatment of petroleum and diesel wastewater from petroleum and oil production refineries. Petroleum is quantified by measuring the polyaromatic hydrocarbon (PAH) concentration, a component of petroleum products, or the total petroleum hydrocarbons (TPHs) present.

Table 3. Effects of Petroleum on Wastewater Treatment Processes.

<b>Effect</b>	<b>Influent pollutant Concentration (mg/L)</b>	<b>Type of system</b>	<b>Average Removal Efficiency</b>	<b>Reference</b>
Reduced removal efficiency	$7.6 \times 10^{-4} \pm 5.7 \times 10^{-4}$ PAH	Conventional Activated Sludge	67.4%	(Fatone et al. 2011)
Reduced removal efficiency	$2.19 \times 10^{-4} \pm 2.10 \times 10^{-4}$ PAH	Separated Sewer System	80.1%	(Ozaki et al. 2015)
Increased sludge viscosity, degradation of sludge dewaterability	20 TPH (dosed)	Membrane Bioreactor (MBR) Pilot Plant	50%	(Mannina et al. 2016)
Reduced removal efficiency	$126 \pm 30$ TPH	Activated Sludge	98-99%	(Tellez et al. 2002)
Increase in toxicity	$340.7 \pm 25.4$ TPH	Bioreactor with specific biopreparation	89%	(Steliga, Jakubowicz, and Kapusta 2015)
Decreased activated sludge oxygen uptake	$1 \times 10^4$ Diesel Oil (dosed)	Return Activated Sludge	-	(Lipczynska-Kochany and Kochany 2008)

Studies are listed in order of increasing contaminant concentration PAH, polyaromatic hydrocarbons; TPH, total petroleum hydrocarbons

Concentrations and systems varied among the studies. Detrimental effects such as decreased oxygen uptake, increased viscosity, and increased toxicity were observed. The focus of these studies was treating oil production facility waste, and likely influent oil concentrations would be much lower for recreational boat waste.

## Methods

### *Sample Collection and Storage*

Activated sludge, recreational boat waste, and seawater samples were collected in Thermo Scientific Nalgene HDPE Bottles transported on ice and stored at 4 C°. Boat waste samples were collected from pumpout vessel holding tanks with a siphon (Dayton Siphon Polyethylene Hand Pump, model 4HA29). Dates and locations of sampling events are listed in Appendix B.

Sampling Events and Tests Performed. along with tests performed.

Sample additives were purchased at a Lopez Island marine store in March 2017. The additives selected were Thetford Ecosmart Formaldehyde-Free Holding Tank Deodorant (“Ecosmart Deodorant”), Thetford Ecosmart Enzyme Holding Tank Additive (“Ecosmart Enzyme”), and Thetford Marine Aqua-Kem Holding Tank Deodorant (“Aqua-Kem”). These products were selected as they were among the highest-selling additives.

### *Characterization of Wastes*

Analysis was performed within 48 hours of collection.

Salinity and pH were measured with an Orion conductivity cell (model 0131010MD) and ROSS Ultra pH/ATC Triode (model 8107UWMMD), respectively. Samples were mixed on a stir plate during probe insertion. TSS, VSS, TS, and TVS were measured using Standard Methods number 2540 (Rice and Bridgewater et al. 2012) using glass microfiber filters with a pore size of 1.2 µm. COD was measured using Hach kit 2565115, free ammonia was measured using Hach kit 2606945, and phosphate concentrations were measured using Hach kit 27425-45. Each was

measured following the manufacturer's instructions. Samples were diluted with DI water prior to testing when necessary to meet the manufacturer's specification for the sampling range.

### *Chemical Profiling Analysis*

Boat waste liquid and solid were separated via centrifugation at  $2783 \times g$  for 30 minutes at  $4^{\circ}\text{C}$ . 1 L of supernatant was saved for liquid analysis. The cell pellet was first re-suspended in 70% acetonitrile/30% DI water and centrifugation was repeated. Next, the resulting supernatant was extracted, then evaporated using nitrogen gas and reconstituted with 8 mL DI water. Three boat waste additives were diluted in DI water at a volume ratio of 1 mL additive to 1 L water. Labels are as follows: Additive 1 is Thetford Aqua-Kem Holding Tank Deodorant, additive 2 is Thetford Ecosmart Holding Tank Deodorant, and additive 3 is Thetford Ecosmart Enzyme Holding Tank Additive. The final solutions were processed using solid phase extraction methods described next.

A Waters Vacuum Extraction Manifold was used to draw 1 liter of sample through an Infinity SPE cartridge (uses a proprietary organosilica media known as Osorb) and eluted using 2.5 mL methanol. Cartridges were preconditioned using 3 mL 50% methanol followed by 25 mL DI water and post-conditioned with 10 mL DI water after the sample was fully loaded. The solution was concentrated using nitrogen gas and a Biotage TurboVap instrument and placed into a 1 mL autosampler vial.

Trace organic contaminants in extracted samples were analyzed using the Agilent 6530 Accurate-Mass Q-ToF LC/MS (quadrupole time of flight liquid chromatography dual mass spectrometry) instrument. The HPLC column was the Agilent Eclipse Plus C18 RRHD  $1.8 \mu\text{m}$ ,

2.1 x 100mm. A calibrant was included in each analytical run to ensure mass accuracy and 10 µL internal standard mix were added to each sample to check instrument response and matrix interference. Furthermore, process blanks were incorporated to identify any constituents resulting from chemical impurities. Samples were analyzed using MS only mode, and mobile phase solvents were 5mM ammonium acetate + 0.1% acetic acid in DI and 5mM ammonium acetate + 0.1% acetic acid in MeOH. Other settings were according to Du et al. (2017).

Mass Profiler Professional (MPP, version 14.0) software was used to determine relationships between sample groups and compounds were identified by comparison of mass, isotopic spacing and ratios, and residence times (where available) with compound databases. Data reduction methods are described in Du et al. (2017). Briefly, data reduction was performed by selecting only features which occurred in all replicates, and which did not occur in process blanks. Feature identification was based on a scoring algorithm according to accurate mass, isotopic spacing and ratio, and retention time (where available). A score between 0 (poor match) and 100 (good match) was determined for each compound. Compounds with scores lower than 70 were omitted.

#### *Impact of Boat Waste on Activated Sludge*

Boat waste and activated sludge mixtures at up to 10% boat waste volume were prepared in order to simulate the introduction of this waste into a treatment plant. Additionally, seawater and boat waste additives were separately added to activated sludge at volumes typical of a boat waste sample. This was to determine the effects of two boat waste components on observed trends. For boat waste additives, the boat waste equivalent volume was the manufacturer recommended dosage. The boat waste equivalent volume of seawater was half the volume of boat waste as

seawater was found to contain about twice the salt content of boat waste. The following five tests were determined to be the most representative for describing overall sludge behavior.

### **Specific Oxygen Uptake Rate**

Specific oxygen uptake rate (SOUR) is an indicator of biological activity and was analyzed following Standard Method 2710 B using a Thermo Scientific Orion Dissolved Oxygen (DO) probe. The sample was supplied with 1000 cc/min of air for 30 seconds to increase oxygen levels, dispensed into a 300 mL BOD bottle, and stirred. The probe was inserted, and the DO of the sample was recorded every 30 seconds for 15 minutes or until the trend became clearly non-linear. When oxygen uptake was too fast, mixtures were diluted with tap water in order to slow uptake and determine the rate with some confidence. For tests performed on 7-12-18 (Friday Harbor activated sludge) and 7-9-18 (Eastsound activated sludge) mixtures were diluted 1:1 with tap water. The SOUR was calculated using the slope of all linear points and normalized using the VSS of the sample.

The resulting slopes (oxygen consumption rates) were used to calculate SOUR values:

$$SOUR (mg/g/h) = \frac{\text{oxygen consumption rate (mg/L/min)}}{VSS(g/L)} \times 60 \frac{\text{min}}{h}$$

### **COD Degradation**

The impact of boat waste on COD degradation was studied. Ensure Original Nutritional Shake® was added to 500 mL samples as a COD source at average wastewater influent concentrations (Tchobanoglous et al. 2014). Ensure Shake was used as it contained optimal nutritional ratios, containing 38 g/L protein, 139 g/L carbohydrates, and 25 g/L fats as listed on the label, and 307 g/L COD as measured using Hach methods. 2000 cc/min of air was supplied to the sample along with continuous stirring. At 0, 15, 30, 45, and 90 minutes after the start of aeration, a 3 mL

aliquot was collected, centrifuged at 9,600 ×g for 1 minute, and the supernatant was extracted for analysis. The sample was centrifuged to remove the presence of large microorganisms that may feed on degraded COD sources. Soluble COD (sCOD) was measured using Hach methods. VSS readings were taken in duplicate at the start and end of each trial.

Degradation constants were found graphically using the following formula (Tchobanoglous et al. 2014):

$$\frac{dC}{dt} = kCX$$

Where C is the sCOD in mg/L, k is the first-order degradation constant, and X is the average VSS of the sample. The natural log of the normalized sCOD was plotted versus time, and the slope and corresponding 95% confidence interval was determined for all linear data points.

### **Nitrogen Conversion**

The impact of boat waste on the nitrification rate was determined similarly to COD degradation. 500 mL of nitrifying mixed liquor activated sludge from King County's South Treatment Plant was provided with 194 mg ammonium sulfate salt to simulate average ammonia loading at average wastewater influent volumes (Tchobanoglous et al. 2014) then the sample was stirred and aerated for 3 hours. 7 mL samples were drawn every 30 minutes and placed in ice for the duration. 10 mL of sample was required at the start and finish for VSS testing. After time elapsed, samples were tested for ammonia, nitrate, nitrite, and total nitrogen using corresponding Hach kits (kit numbers 2606945, 2605345, 2608345, and 2714100 respectively).



## Settleability

The sludge volume index (SVI) is an indicator of sludge settling properties. The protocol was described by USABBlueBook®. One liter of sample was poured into a two-liter settleometer then gently stirred using the included paddles. Paddles were removed and the settled sludge volume (SSV) was recorded before and after 30 minutes. SVI was calculated using the ratio of the settled blanket volume to the total sample volume and normalized using the TSS of the sample:

$$SVI = \frac{\text{Sludge blanket volume over total solution volume after 30 min (mL/L)} \times 1000 \text{ (mg/g)}}{TSS \text{ (mg/L)}}$$

## Foaming

Foaming levels of samples were determined using the procedure described by Novak et al. (1990). Briefly, a one liter of sample was poured into a 2000 mL Fisherbrand glass graduated cylinder. The sample was provided with 1000 cc/min of diffused air until maximum foam height was observed. The height of foam was measured with a ruler.

## Data Analysis

For SOUR and COD degradation, the slope and slope error were calculated using Excel's Analysis Toolpak add-in (2016). 95% confidence intervals were verified by hand to confirm Excel's results as follows (Montgomery 2013):

$$S_{xx} = \sum_{i=1}^n (x_i - \bar{x})^2$$

$$SS_{Res} = \sum_{i=1}^n (y_i - \hat{y}_i)^2$$

$$\hat{\sigma}^2 = \frac{SS_{Res}}{n - 2} = MS_{Res}$$

$$se(\hat{\beta}_1) = \sqrt{\frac{MS_{Res}}{S_{xx}}}$$

$$\hat{\beta}_1 - t_{\alpha, n-2} se(\hat{\beta}_1) \leq \hat{\beta}_1 \leq \hat{\beta}_1 + t_{\alpha, n-2} se(\hat{\beta}_1)$$

where,  $S_{xx}$  is the corrected sum of squares for the x data;  $\bar{x}$  is the average value for all x data;  $SS_{Res}$  is the residual sum of squares;  $\hat{y}_i$  is the predicted value based on the calculated trendline;  $\hat{\sigma}$  is the unbiased estimator;  $MS_{Res}$  is the residual mean square;  $se(\hat{\beta}_1)$  is the standard error of the slope; and  $t_{\alpha, n-2}$  is the two-tailed inverse of the Student's t-distribution at an alpha value of 0.05 and a probability of 2 less than the number of data points.

The errors for SOUR and SVI were propagated through the following formula (Garland 2009):

$$\frac{\Delta^2(F)}{F^2} = \frac{\Delta^2(x)}{x^2} + \frac{\Delta^2(y)}{y^2} + \frac{\Delta^2(z)}{z^2}$$

Where  $F = axyz$  or  $axy/z$  or  $ax/yz$  or  $a/xyz$  and “a” is a numeric constant. In SVI calculations, the error of the settled sludge volume (SSV) readings were set to 5 units due to the limitations of the settleometer. The above formula was also applied to find the error in the normalized (SOUR/SOUR<sub>0</sub> and SVI/SVI<sub>0</sub>) values. Normalized results were relative to solutions with only activated sludge present.

Random error associated with TSS and VSS was determined by calculating average deviations of replicates and used in the propagation formula as well. Since the deviation increased as the average suspended solids increased, the average deviation was plotted versus the average value and a trendline was plotted. The error associated with TSS and VSS in each SOUR and SVI trial was determined using this linear regression line ( $R^2 = 0.96$  for TSS and 0.90 for VSS). The

purpose of this method was to fill in gaps of data in which the error of a specific TSS or VSS measurement was unknown.

In foaming calculations, the error associated with each location-specific sludge was determined by performing 10 foaming trials and calculating the average deviation. A foaming agent was added (boat waste or deodorant) in the case the sludge did not exhibit foaming by itself.

## **Results**

### *Wastewater Treatment Plant Operator Interviews*

Conversations with treatment plant operators took place in March of 2017. Operators were asked if they had concerns about accepting recreational boat waste to their facilities. Eastsound treatment plant is a secondary-only facility, so the absence of solids removal led to concerns about the high solids content of boat waste. At the Lopez Island wastewater treatment facility, petroleum contaminants that may enter the waste stream through bilge water or spills were identified as a high concern. An additional concern was the impacts of anti-microbial agents on anaerobic treatment processes. In Friday Harbor, seasonal fluctuations in influent salinity concentration have been observed, which is detrimental to flocculation. It should be noted Friday Harbor Wastewater Treatment Plant currently accepts a small volume of recreational boat waste from Friday Harbor Marina, but this source has never been greater than 1% of the total influent composition. Additional concerns are listed in Table 4.

Table 4. San Juan Island Treatment Plant Operator Concerns.

<b>Wastewater Treatment Plant</b>	<b>Operator Concerns</b>
<b>Eastsound (Orcas Island)</b>	<ul style="list-style-type: none"> <li>• Impact of high solids on high-head effluent pumps</li> <li>• Chemical disruption of biological activity</li> </ul>
<b>Fisherman Bay (Lopez Island)</b>	<ul style="list-style-type: none"> <li>• High chlorides in anaerobic step</li> <li>• Fuels and diesels from boat bilges</li> <li>• Inhibition of anaerobic biologic activity</li> </ul>
<b>Friday Harbor</b>	<ul style="list-style-type: none"> <li>• Saline waste toxicity</li> <li>• Chemicals causing increased foaming and disruption of flocculation (additive chemicals responsible for plant shutdown in 1990's)</li> <li>• Dissolved oxygen levels hard to maintain in summer months, so high BOD a concern</li> <li>• High boat waste loads during weekends (no staff)</li> </ul>

#### *Survey of Boat Waste Additives*

Active ingredients of several purchasable additives are listed in Table 5. Based on these ingredients, the mode of action for boat waste additives can be divided into three primary categories: biocides – which kill all microbial activity to inhibit production of unpleasant-smelling microbial by-products, de-flocculants – which disperse solid wastes to avoid degradation in holding tanks, and enzymes – which target specific unpleasant by-products. Note the absence of anti-microbial ingredients such as zinc and formaldehyde, which have historically been used in boat waste additives (Robins and Green 1974). Biocides are a concern for wastewater treatment plants as they may inhibit the biological activity responsible for wastewater treatment. Surfactants and deflocculants have potential to impede sludge settling at a wastewater treatment plant, which would interfere both with the facility's ability to re-cycle their active microbial biomass (*aka* activated sludge) and could cause discharge violations should unsettled

solids be released with the facility's treated effluent. The impacts of enzymes on wastewater treatment facilities would be dependent on the mode of action of the enzyme, which is not necessarily readily apparent based on listed active ingredients. Additional ingredients of potential concern to wastewater treatment included phosphates, which often has limits for discharge concentrations from wastewater treatment facilities, and sulfate, which has potential to cause noxious sulfide emissions from a wastewater treatment facility.

Table 5. Chemical Composition of Purchasable Boat Waste Additives.

<b>Active Ingredient</b>	<b>Suspected Action</b>	<b>Example product(s)</b>
Bromopol	Biocide	Aqua-Kem Deodorant, Max Control Free Liquid, Max Control Free Dry
Ethoxylated alcohol	Biocide, de-flocculant	Aqua-Kem Deodorant, EcoSmart Deodorant, EcoSmart Enzyme
Calcium nitrate tetrahydrate	De-flocculant	EcoSmart Deodorant
Alkylpolyglucoside	Enzyme	EcoSmart Deodorant
Nonionic surfactant	Surfactant, de-flocculant	Max Control Free Liquid
Monosodium phosphate		Max Control Free Dry
Sodium Sulfate		Max Control Free Dry

Max Control products were produced by Dometic/Sealand Technologies in 2017.

### *Characterization of Wastes*

Basic characterization of boat wastes used in this study are presented in Table 6 and Table 7, with comparison to typical wastewater influent, activated sludge samples, and seawater. Notably,

boat waste was found to be significantly higher in pH as well as salinity, ammonia, and TSS concentrations when compared to Friday Harbor wastewater influent (see tables for t-test results). Furthermore, characteristics of samples tended to vary between sampling dates as indicated by average deviations. It should be noted Friday Harbor activated sludge solids content is highly dependent on the settling within the sequencing batch reactor when the sample was taken. Settling fluctuates with the batch reactor cycles.

Table 6. Characterization of Waste Components.

Sample Location	Replicates*	Sample Parameters				
		pH	Salinity (ppt) <sup>†</sup>	Ammonia (mg/L NH <sub>4</sub> -N)	COD (mg/L) <sup>‡</sup>	Phosphate (mg/L)
<i>Recreational Boat Waste</i>						
Portage Bay <sup>§</sup>	5	8.04 ± 0.22	6.52 ± 0.31	1252 ± 247	7167 ± 471	186 ± 9
Friday Harbor**	2	8.45 ± 0.19	8.47 ± 1.74	666 ± 435	4790 ± 988	
Comparison to Wastewater Influent (t-test, α=0.05)		<i>p</i> = 0.002	<i>p</i> = 0.0001	<i>p</i> = 0.0005		
<i>Activated Sludge<sup>††</sup></i>						
South Plant	3	7.25 ± 0.17	0.41 ± 0.06	31.0 ± 14.8	3373 ± 234	66 ± 25
West Point	1	6.84	0.52	30.6	2527	
Friday Harbor	3	7.40 ± 0.06	0.53 ± 0.07	21.3 ± 1.5	1999 ± 1016	
Eastsound	3	7.27 ± 0.30	0.46 ± 0.08	20.4 ± 16.8	2804 ± 503	
<i>Seawater</i>						
Golden Gardens <sup>‡‡</sup>	1		22.87			
Friday Harbor	2		23.35 ± 0.54			
<i>Wastewater Treatment Plant Influent</i>						
Friday Harbor WWTP <sup>§§</sup>		7.49 ± 0.06	0.28 ± 0.10	17.0 ± 4.1		
Untreated Domestic Wastewater <sup>***</sup>		7.0 - 8.0	0.34 - 0.60	8 - 25	250 - 800	4 - 12

\* Does not apply to phosphate results

† Parts per thousand

‡ COD = Chemical Oxygen Demand

§ Collected from Terry and Sons mobile pumpout vessel

\*\* Collected from Port of Friday Harbor pumpout vessel at Friday Harbor Marina

†† Activated sludge sample locations correspond to wastewater treatment plants in King County and San Juan Islands, listed in Appendix B

‡‡ Golden Gardens is a beach park in Northwest Seattle

§§ Average monthly values from Jan 2017 to Feb 2018 were supplied by Friday Harbor Wastewater Treatment Plant

\*\*\* (Henze 2008, Tchobanoglous et al. 2014)

Table 7. Solids Characterization of Waste Components.

Sample location	Replicates	Sample Parameters*			
		TSS (mg/L)	VSS (mg/L)	TS (mg/L)	TVS (mg/L)
<i>Recreational Boat Waste</i>					
Portage Bay	5	1374 ± 714	1087 ± 597	3947 ± 1081	1694 ± 750
Friday Harbor	2	1219 ± 591	698 ± 242	7118 ± 1313	1905 ± 115
Comparison to Wastewater Influent (t-test, α=0.05)		<i>p</i> = 0.014			
<i>Activated Sludge</i>					
South Plant	3	2172 ± 209	1812 ± 221	2434 ± 217	1929 ± 217
West Point	1	1520	1370	1940	1420
Friday Harbor	3	1567 ± 611	1351 ± 499	1817 ± 532	1310 ± 573
Eastsound	3	2755 ± 237	2293 ± 171	3113 ± 371	2473 ± 224
<i>Seawater</i>					
Golden Gardens	1	23.8	2.6	21043	4643
Friday Harbor	2	44.8 ± 7.4	8.9 ± 3.7	26020 ± 7010	4113 ± 553
<i>Wastewater Treatment Plant Influent</i>					
Friday Harbor WWTP <sup>†</sup>		162 ± 27			
Untreated Domestic Wastewater <sup>‡</sup>		120 - 400	95 - 315	390 - 1230	110 - 340

\* TSS = total suspended solids, VSS = volatile suspended solids, TS = total solids, TVS = total volatile solids

<sup>†</sup> Average monthly values from Jan 2017 to Feb 2018 were supplied by Friday Harbor Wastewater Treatment Plant

<sup>‡</sup> (Tchobanoglous et al. 2014)

### *Chemical Profiling of Boat Waste and Additives*

Chemical constituents from three different boat waste additives and boat waste sample were

compared using Mass Profiler Professional (MPP, version 14.0) software as shown in Figure 3.



Boat waste results were a combination of compounds identified from solid and liquid analysis. The presence of common compounds between boat waste and additives shows additive compounds can be identified within a boat waste sample. This suggests both the use of these additives by recreational boaters, and that some compounds persist in boat waste holding tanks.

Common compounds were found between the 3 unique additive solutions. Additives 2 and 3 were similar, as demonstrated in Figure 3a. 192 total compounds were identified in additive 1, while 476 and 489 were identified in additives 2 and 3, respectively. Furthermore, 30% of additive 1 compounds were present in boat waste whereas 76% and 77% of additive 2 and 3 compounds were present in boat waste (Figure 3). 26 constituents were found in all additive and boat waste samples.

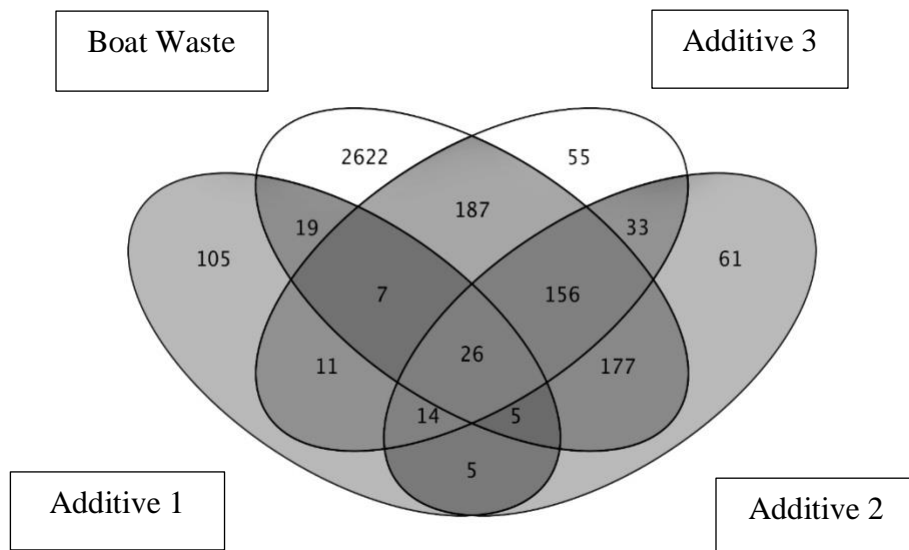

Figure 3. Unique and Concurrent Features for Boat Waste and Additives.

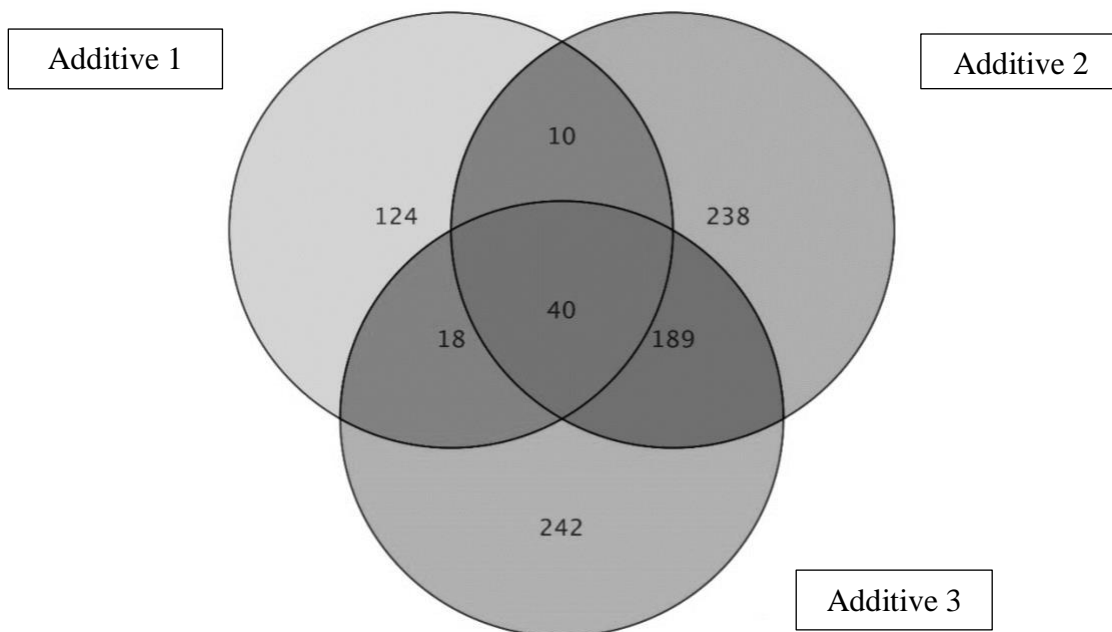

Figure 3a. Unique and Concurrent Features for Three Boat Waste Additives.

Figure 3 demonstrates a comparison between analysis of the boat waste supernatant and cell pellet. 51% of all boat waste compounds were found both in the liquid and solid portion. The breadth of compounds captured during pellet analysis may have been narrower than expected due to the resuspension of solvent supernatant in DI water rather than acetonitrile solution. Compounds solubilized by acetonitrile in the previous step may have remained outside the water solution.

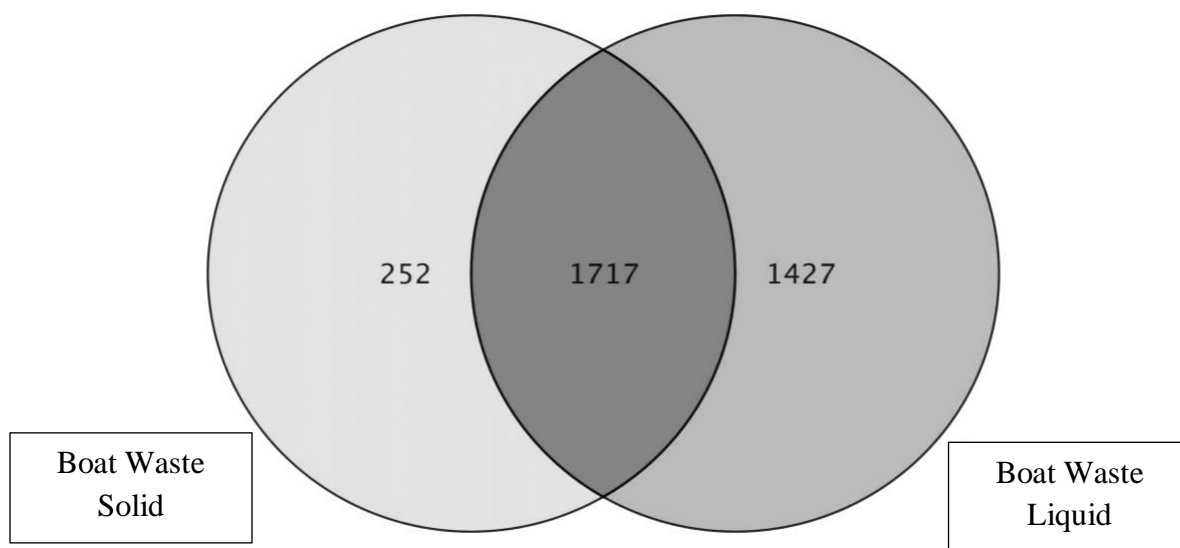

Figure 4. Unique and Concurrent Features for Boat Waste Solid and Liquid.

Mass and retention times of the 26 concurrent features were compared to a compound database, which yielded the 10 identifiable compounds listed in Table 8. Other compound scores were too low to accurately predict a compound name. When possible, chemical structures were identified, and additional information was collected from online chemical databases. Databases accessed were the Human Metabolome Database (HMDB) (Wishart et al. 2018) and Pubchem (Kim et al. 2016). Surfactants and antiseptics are assumed to originate from boat waste additives (likely present within the boat waste sample as well).

Compound formulae are tentative and given a level 3 classification on a 5-level scheme according to Schymanski et al. (2014). Missing evidence such as MS/MS data, reference standards, and diagnostic evidence weaken identification confidence. Within the level 3 classification, tentative structure scores are provided in Table 8.

Table 8. Compounds Present in Boat Waste and All Boat Waste Additives.

Compound	Type/Suspected Purpose	Score
6-Hydroxy-8-docosanone	Surfactant	92.48
2-O-methyl PAF C-16	Surfactant	71.59
PA (17:1(9Z)/0:0)	Surfactant	99.04
3,5-Di-O-methyl-8-prenylafzelechin-4beta-ol	Flavonoid	99.93
Hydroxytyrosol 1-O-glucoside	Non-ionic surfactant	89.11
Istamycin AP	Carbohydrate nutrient	99.43
4'-(Dimethylamino)azoxybenzene n-oxide	Organonitrogen heterocyclic compound, pyridazine	94.80
Demethoxyshogaol	Phenol (surfactant-like)	89.33
Elatine	Organonitrogen heterocyclic compound, pyrrolidine	97.45
DG (14:1(9Z)/24:0/0:0)	Surfactant	95.05

#### *Impact of Boat Waste on Microbial Activity*

#### **Specific Oxygen Uptake Rate**

The linear range of oxygen uptake was identified according to Figure 5. Oxygen uptake results for all trials can be found in Appendix C.

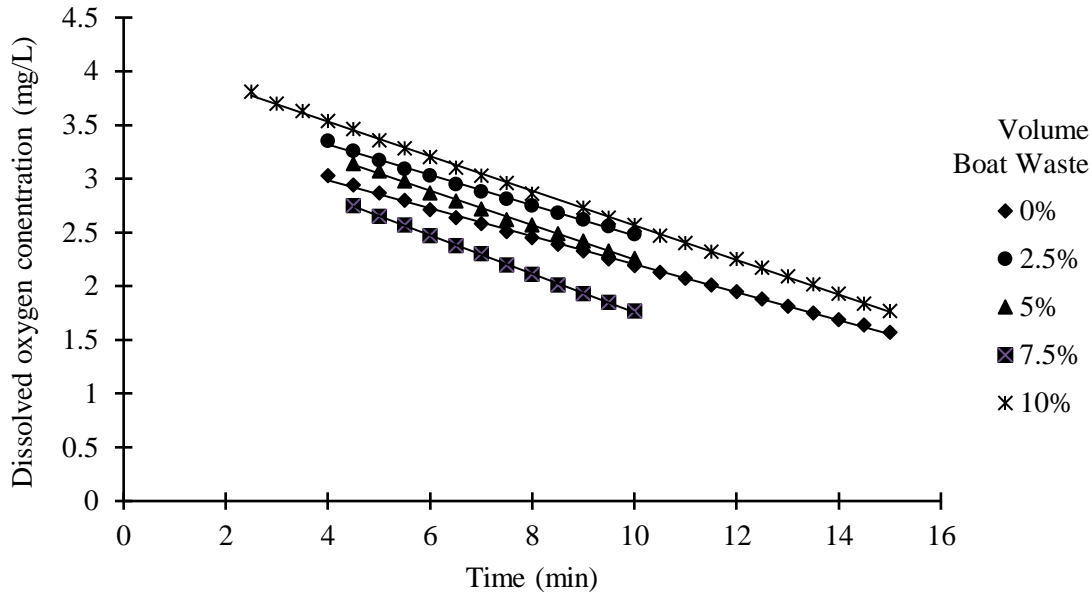

Figure 5. Example Oxygen Uptake During SOUR Trials.

The rate of oxygen uptake by system microbial biomass was used as an indicator of microbial activity. Comparisons of oxygen uptake rates following addition of boat waste and boat waste components (seawater and Aqua-Kem Deodorant) were used as a measure of potential for boat waste to impact treatment plant biologic treatment activity. Aqua-Kem specifically was expected to impede biologic activity due to potentially harmful chemicals.

As demonstrated in Figure 6, impacts of boat waste on SOUR varied between testing events. Results were normalized to tests in which no boat waste was present as activated sludge SOUR also varied between testing events (Figure D1). No clear correlation between boat waste concentration and SOUR was observed in activated sludge from South Plant and Friday Harbor in 2017. SOURs were elevated (within the confidence interval) in 2017 Eastsound samples at boat waste concentrations of 5% and 10%. In 2018, Friday Harbor activated sludge showed an

increase in SOUR as boat waste concentrations increased to 7.5% volume. Finally, SOUR clearly increased as boat waste concentrations increased to 10% in Eastsound 2018 samples.

Additions of Seawater and Aqua-Kem to activated sludge did not result in the same increases in SOUR, indicating these boat waste components were not responsible for the observed trends (Figure D2 and Figure D3).

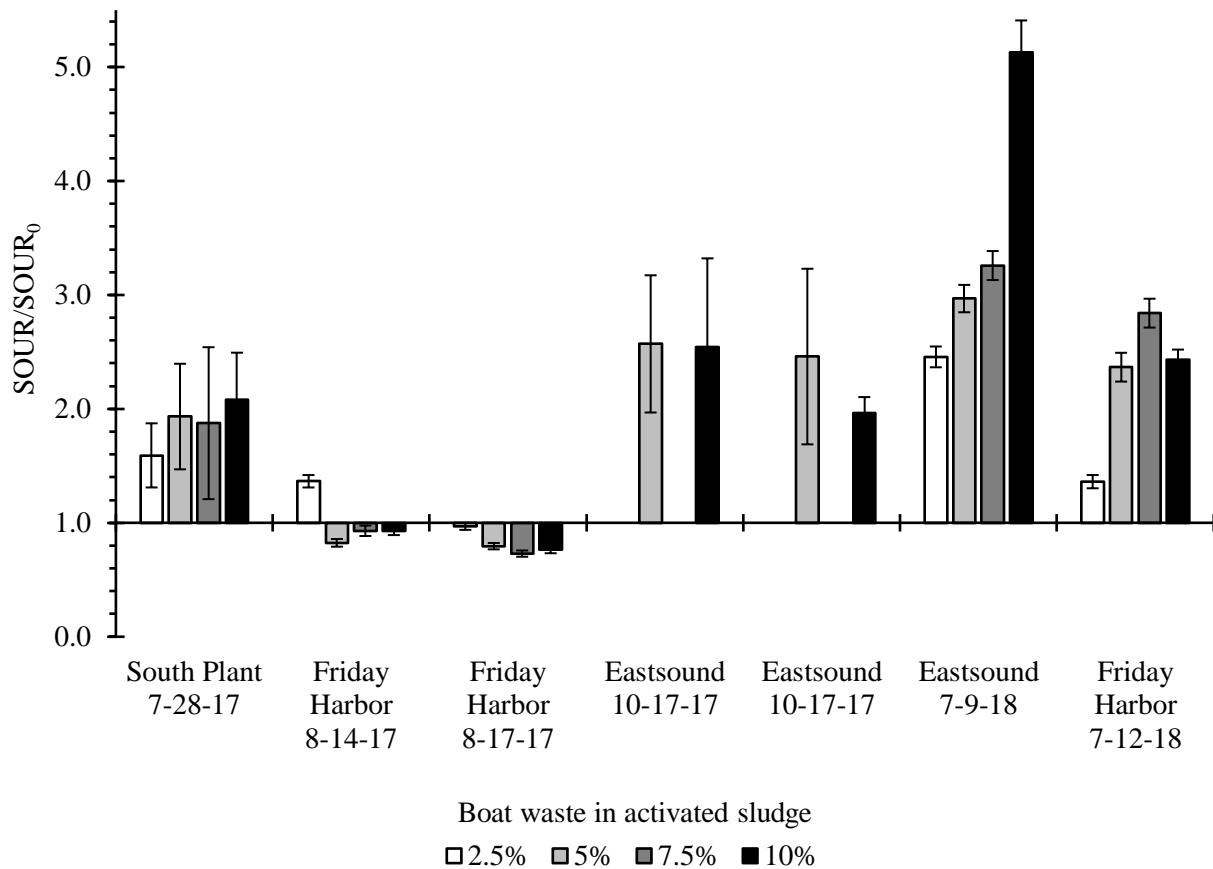

Figure 6. SOURs of boat waste and activated sludge mixtures. 95% confidence intervals of oxygen uptake rates are shown. Results are normalized to mixtures in which no boat waste was added.

## COD Degradation

Activated sludge degrades wastewater COD over time as a part of the treatment process. A higher first-order degradation constant indicates a higher-performing sludge. South Plant, Friday Harbor, and Eastsound activated sludge showed a significant decrease in degradation at 10% boat waste volume. However, South Plant sludge showed an increase in degradation at 5% boat waste, indicating biological activity was enhanced at lower boat waste volumes, but toxic effects dominated as volume increased. At boat waste volumes of 5% and 10% in Eastsound sludge, degradation was highly variable (not linearly decreasing) as indicated by relatively large error bars.

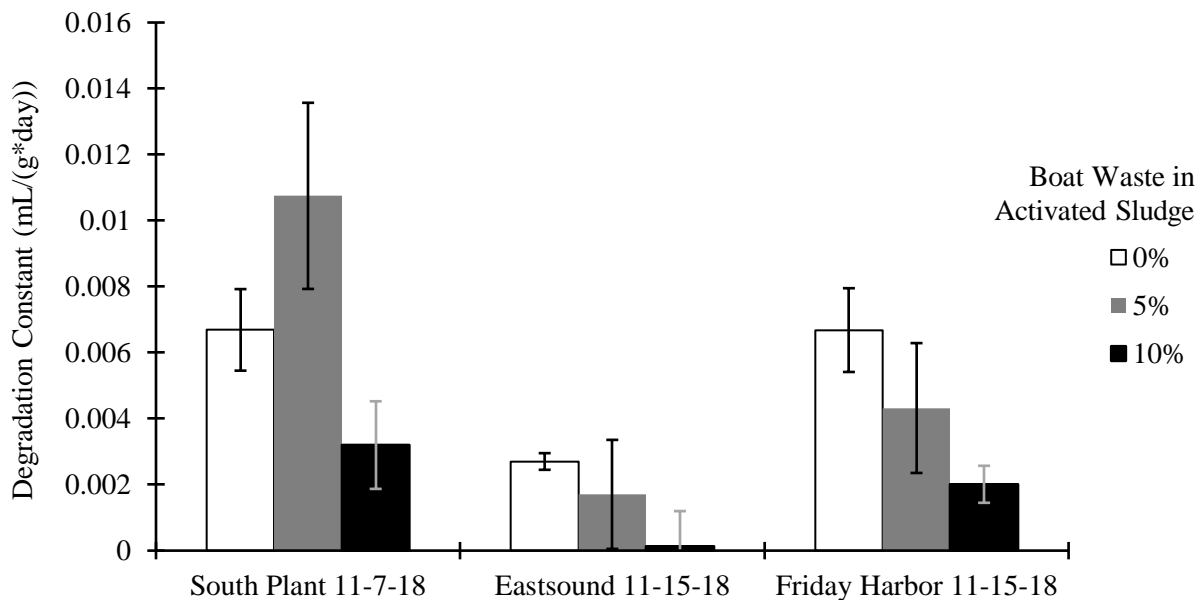

Figure 7. COD degradation constants of boat waste and activated sludge mixtures. Error bars represent 95% confidence intervals of the graphical solution.

## **Nitrogen Conversion**

When nitrifying sludge is aerated, microorganisms convert ammonia to nitrate and nitrite. The activity and abundance of nitrifying microorganisms determines the rate of conversion, and boat waste was expected to cause disruptions due to interference by additive chemicals. Nitrogen concentrations in aerated South Plant activated sludge with and without 10% boat waste are plotted in Figure 8 and Figure 9, respectively. In the boat waste mixture, total nitrogen and ammonia concentrations are higher throughout the test due to the high nitrogen content of boat waste. In both tests, an increase in nitrate and nitrite concentration indicates the existence of nitrification which demonstrates nitrification can occur at boat waste volumes of up to 10%. The presence of boat waste resulted in a faster increase in nitrite relative to nitrate, which hints at the selective impact of boat waste on nitrite oxidizing microorganisms. Perhaps due to limitations of intermittently nitrifying sludge (King County South Treatment Plant does not support nitrification year-round), only partial nitrification was observed as conversion of ammonia was incomplete. Thus, these results are preliminary and only hint at a specific interference by boat waste.



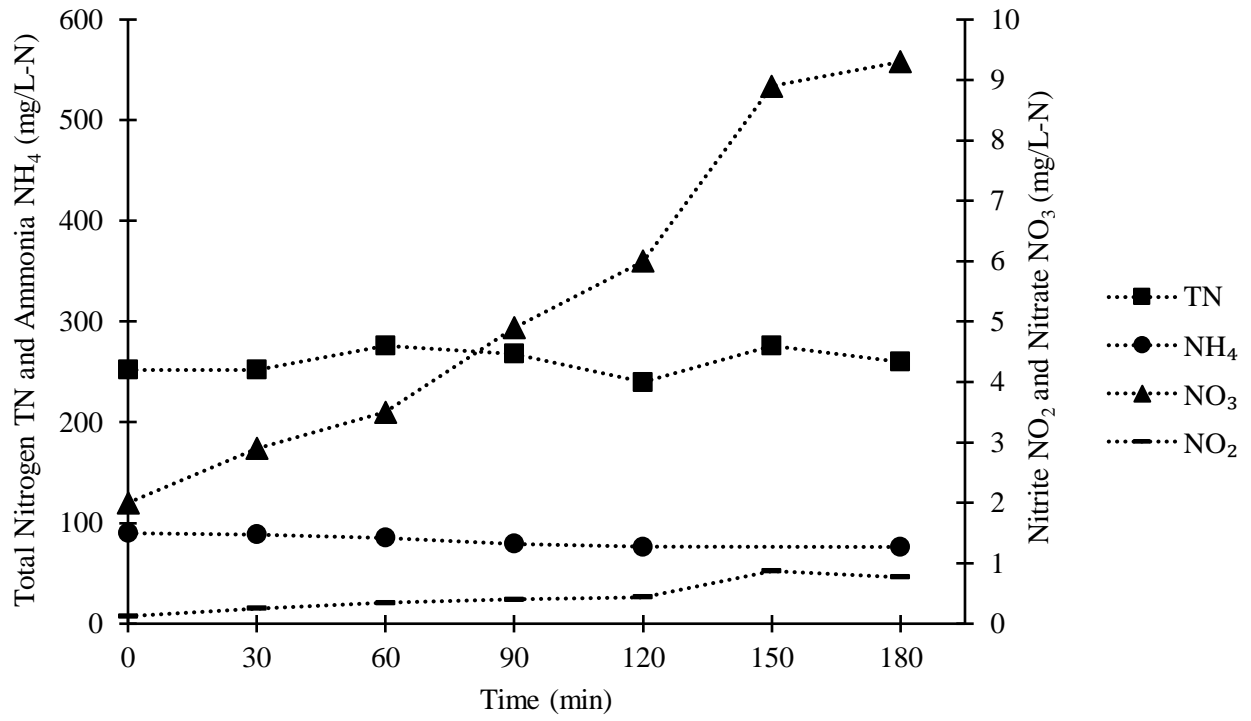

Figure 8. Nitrogen Species in Aerated Activated Sludge.

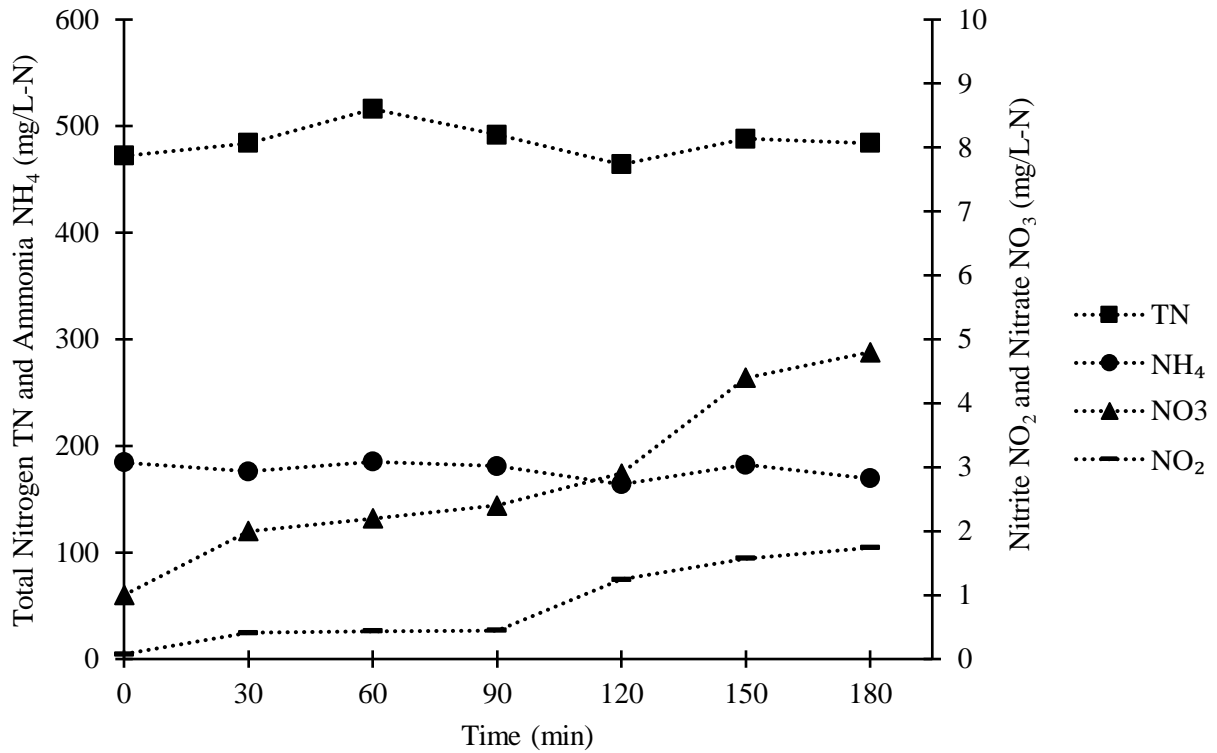

Figure 9. Nitrogen Species in an Aerated Boat Waste (10%) and Activated Sludge Mixture.

### *Impacts of Boat Waste on Activated Sludge Physical Responses*

#### **Settleability**

Activated sludge settling ability did not always increase as was hypothesized for boat waste additions. Increased activated sludge settling with boat waste addition was expected due to the disruption of filamentous biomass. Settling properties of activated sludge samples were studied via the SVI (sludge volume index) test. A decrease in SVI indicates increased settleability while a high SVI indicates poor settling characteristics. SVI was similar among most activated sludge samples except for Friday Harbor in 2017, which was nine times higher than South Plant activated sludge in the same year (see Figure D4).

In general, sludge volume index showed less response to boat waste concentration than oxygen uptake rate. SVI slightly decreased in activated sludge samples from South Plant in 2017 at boat waste concentrations of 5% and 10%. Surprisingly, SVI clearly decreased in Friday Harbor 2017 samples as boat waste was added but showed no clear correlation in the same samples in 2018. Separate additions of Aqua-Kem Deodorant and seawater did not significantly affect SVI in Friday Harbor 2017 samples, indicating decreased SVI was a result of another boat waste component or combination of components (Figure D5 and Figure D6).

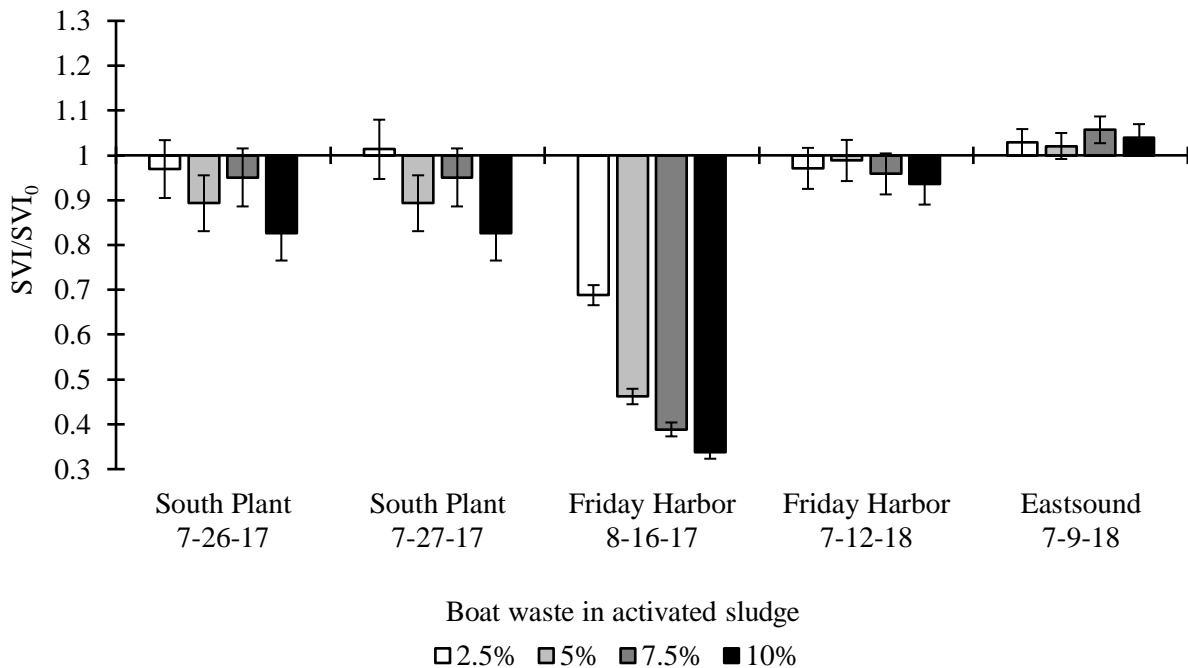

Figure 10. SVI of boat waste and activated sludge mixtures. Error bars represent glassware limitations and TSS confidence (used to normalize SVI). Results are normalized to mixtures in which no boat waste was added.

### Foaming

Due to the presence of surfactants in boat waste additives, foaming was predicted to increase in activated sludge samples with the addition of boat waste. Figure 11 shows non-normalized max

foam heights for activated sludge and boat waste mixtures. When boat waste was added to South Plant activated sludge, an increase in foam height was observed at boat waste volumes of 7.5% and 10%. In Friday Harbor activated sludge, an increase in foam height was observed at volumes of 2.5% and 10%. In West Point activated sludge, an increase was observed at 7.5% and 10%. Experimental error was determined by performing 10 foaming trials with activated sludge only (except in South Plant sludge, in which Aqua-Kem was added to each trial) and calculating average deviations. Eastsound activated sludge did not exhibit foaming at any boat waste concentration of up to 10%.

A similar increase in foaming was observed upon addition of Aqua-Kem Deodorant (Figure D7), indicating boat waste additives could contribute to foaming caused by boat waste. Seawater did not affect activated sludge foaming (Figure D8).

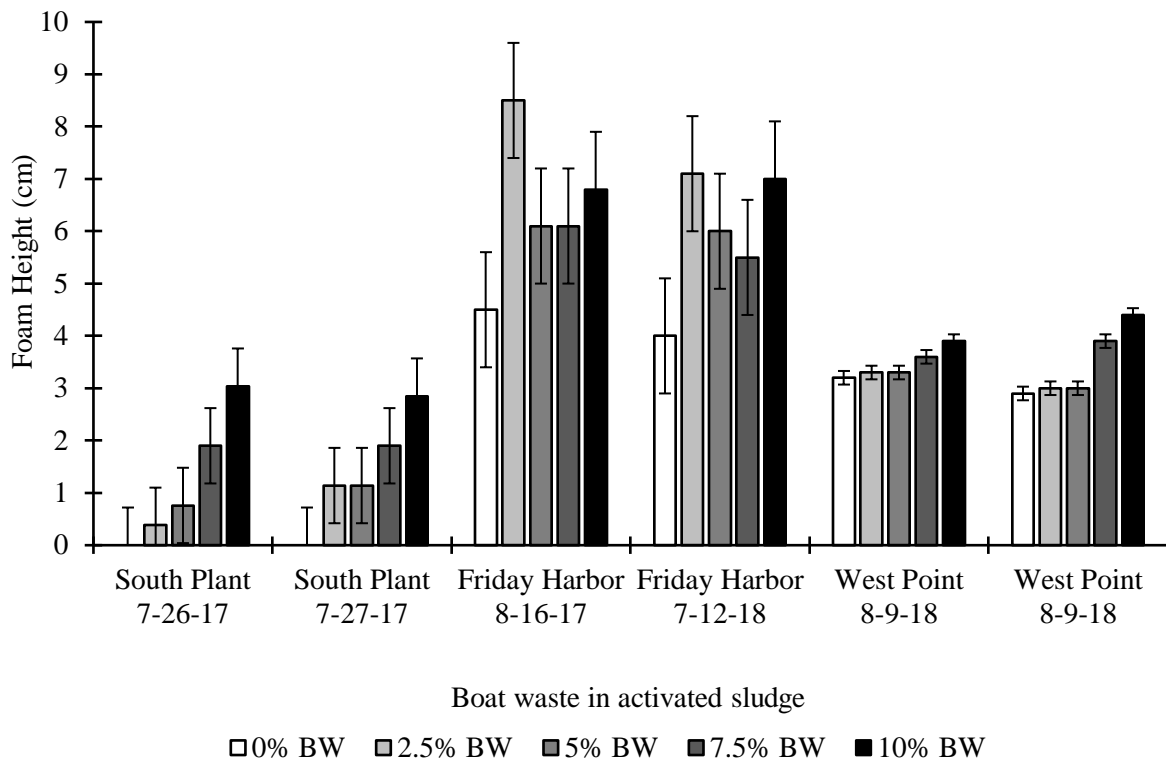

Figure 11. Foaming in boat waste and activated sludge mixtures. The average deviation of each sludge was determined from 10 foaming trials.

### *Boat Waste Component Impact*

Thetford Aqua-Kem Holding Tank Deodorant and seawater impacts on activated sludge were studied parallel to boat waste impacts and results are presented in Table 9. Notably, the addition of Aqua-Kem Deodorant resulted in foam height increases from 0 cm to  $4.6 \pm 0.7$  cm and 0 cm to  $5.3 \pm 0.7$  cm in South Plant activated sludge (Figure D7). Full graphical results are present in Appendix D. Non-Normalized SOUR and SVI Results and Impacts of Boat Waste Components on Activated Sludge Behavior. When no clear impact was observed, the conclusion was that another boat waste component or combination of components is responsible for the observed

trend. These results indicate boat waste additives were at least partially responsible for increased activated sludge foaming when boat waste is present.

Table 9. Direction of Observed Impacts of Salt and Boat Waste Deodorant on Activated Sludge.

Testing Method	Boat Waste	Deodorant	Seawater
SOUR	Increase	None	None
SVI	Decrease	None	None
Foaming	Increase	Increase	None

Note: The deodorant was Thetford Marine Aqua-Kem Holding Tank Deodorant.

## Discussion

When municipal wastewater treatment plants consider accepting an additional wastewater stream, it is critical to understand the potential impacts that this new influent will have on their operations. This is particularly crucial when the new influent might substantially impact the characteristics of wastewaters entering the biological treatment process. In this study, the high strength waste stream from recreational boat toilets was considered.

Research results agreed with prior studies in many cases despite changes to boat waste additive composition over the years. Boat waste was found to contain high concentrations of COD, total suspended solids (TSS), and ammonia in this study (Table 6 and Table 7) and previous studies (Table 2) when compared to wastewater influent. Characterization agreed with reported values within the calculated error apart from Friday Harbor boat waste, which was found to be significantly lower in TSS. Furthermore, boat waste additives were linked to increased foaming in activated sludge, a finding supported by Novak et al. (1990). In addition to COD, TSS, and

ammonia, characterization testing revealed boat waste salinity and phosphate concentrations were significantly greater than typical raw wastewater concentrations.

Treatment of high ammonia waste is a concern in the Puget Sound region especially because regulations on effluent ammonia concentrations do not exist for most treatment plants that discharge into the Puget Sound (McCarthy and Mohamedali 2017). As a result, several large treatment plants only seasonally nitrify or do not support nitrification at all within their treatment operations (Personal Communication 2018). The largest wastewater sources of dissolved inorganic nitrogen (DIN) in the Puget Sound are Everett South Treatment Plant (1,990 kg/day), King County West Point Treatment Plant (10,450 kg/day), King County South Treatment Plant (8,875 kg/day), and Tacoma Central Treatment Plant (1,910 kg/day) (McCarthy and Mohamedali 2017). DIN loads into the Puget Sound are projected to double from 32,200 kg/day by 2070 with population growth if wastewater treatment plants do not upgrade to higher nitrogen removing technologies (Roberts et al. 2014).

Characterization revealed substantial constituent fluctuations for boat waste collected on different days (Table 6 Table 6. Characterization of Waste Components. and Table 7). This is not an unexpected result, as each pumpout station would service different vessels at differing times. Interestingly, COD concentrations were particularly susceptible to fluctuations (Table 6), which may be due to the state of microorganisms during sample events. Several factors might contribute to variation in COD. A microbial death event causes a decrease in COD and can be caused by fluctuations in temperature and toxic substances as well as lack of nutrition. Alternatively, boat waste additives were found to be a COD source, so boat waste COD could

vary depending on the volume added to individual holding tanks. Ranges and calculated deviations for COD characterization were similar or larger in previous studies (Oregon State Marine Board 1995, Robins and Green 1974, Watson 2005). COD is proportional to volatile solids, so perhaps unsurprisingly Portage Bay boat waste showed the most fluctuation in VSS and TVS concentrations of all boat waste and activated sludge samples (Table 7). The Oregon State Marine Board (1995) also found boat waste solids to deviate considerably, with TSS and VSS concentrations  $1370 \pm 1590$  and  $1600 \pm 1910$  mg/L, respectively. Due to this heterogeneity, facilities receiving boat waste might expect variable operational results when boat waste strengths fluctuate.

Perhaps due to variable boat waste characteristics, boat waste impacts to activated sludge also varied with date and sample location. For instance, SOUR increased in Eastsound (Orcas Island) activated sludge as boat waste was added but remained constant in South Plant (King County) sludge (Figure 6). This may be due to the wide variety of microbial community structures among activated sludge treatment plants (Yang et al. 2011). Variations in settleability results with sample locations and dates can be explained by heterogeneity of activated sludge and boat waste samples. Notably, Friday Harbor activated sludge was tested in summer of 2017 and 2018, but SVI was only found to be significantly impacted by boat waste in 2017. Waste characterization data revealed solids concentrations were significantly higher in 2018 activated sludge ( $p = 0.005$ ) which could have altered physical characteristics of the mixture. Foaming results were more consistent between sampling dates in all sludges, indicating foaming is less sensitive to fluctuating constituent parameters such as solids and COD concentrations.



The impact on sludge COD degradation by boat waste varied among the tested sludge but consistently decreased at volumes of 10% boat waste (Figure 7). In South Plant activated sludge, degradation increased at 5% boat waste and decreased at 10% boat waste, which may demonstrate what is known as the subsidy-stress gradient (Odum et al. 1979). This phenomenon occurs when a system encounters an input that provides usable material at low doses but exhibits a toxic effect as concentrations increase. It is likely boat waste inhibited sludge microorganisms at 10% boat waste concentrations but acted as a COD or nutrient source at lower concentrations. This is in contrast to SOUR testing, for which increases in microbial activity were observed at up to 10% boat waste concentration. One explanation for this contradiction is the difference in exposure time between the two testing methods: boat waste exposure was 90 minutes long in COD degradation testing and only a maximum of 15 minutes long in SOUR testing. Another explanation between the apparent contradiction is the mathematical interpretation. In COD degradation testing, a rate constant was calculated rather than the rate itself. A rate constant is not affected by changes in concentration, so changes in sCOD between trials (higher when boat waste is added) are not reflected in COD degradation analysis.

The start of nitrification was demonstrated in activated sludge and sludge dosed with 10% boat waste (Figure 8 and Figure 9) which requires functional nitrifying organisms be present. Since nitrification was observed in both trials, sludge biology seems to be unaffected. However, nitrate and nitrite accumulation revealed a modification to nitrification when boat waste was added. Even though ammonia concentrations are nearly double in the boat waste solution, nitrate accumulation is half what is observed without boat waste. Furthermore, the accumulation of nitrite is double in the boat waste solution. In a 10% boat waste solution the conversion of nitrite

to nitrate seems to be hindered, causing a buildup of nitrite and a lack of nitrate. Selective hindrance of nitrite oxidizing bacteria by boat waste is suggested. It should be noted microorganisms were unable to complete nitrification even without boat waste present, perhaps because King County South Treatment Plant does not support nitrification year-round. Ideally, this research would be performed with activated sludge containing highly functional nitrifiers, and these results will inform experimental design to fully address the phenomena.

Interestingly, the presence of seawater was not found to impact sludge behavior in this study (Table 9). This result was in contrast to previously reported links between salinity and decreases in oxygen uptake and microbial activity in the past (Linarić et al. 2013, Perneti and DiPalma 2005, Pronk et al. 2014, Zhang et al. 2017, Chen et al. 2018). Adaption of microorganisms to saline environments might explain this disparity. Halotolerant (salt-tolerant) species are known that dominate a microbial population in high-saline environments (Madigan et al. 2018) and researchers have been successful in identifying halotolerant bacteria from marine environments (Lim et al. 2008 and Ramana et al. 2008). In treatment plants near saline water sources, it is possible activated sludge microbial communities adapt to saline influent. Sludge cultivated within lab environments likely would not demonstrate the same adaption. Another explanation is the difference in salt concentrations studied previously. Adverse effects to activated sludge processes were observed at salt concentrations of 20 to 40 parts per thousand, whereas seawater concentrations were never greater than 1.2 parts per thousand in our study. Consequently, the salt content of a 10% boat waste mixture may not be high enough to observe inhibitory effects on activated sludge processes.

Chemical profiling and SDS (safety data sheet) lookup provided an updated list of boat waste additive components. Surfactants were identifiable on a chemical level (Table 8). Surfactants are present in most soap and detergent products, and their presence in boat waste additives may contribute to observed foaming increases in boat waste and activated sludge mixtures. Further research is being conducted at the University of Washington Tacoma Laboratories at Center for Urban Waters to identify potential boat waste tracers for use in waste detection and process monitoring.

As treatment of high strength waste is an active current research area (Boonnorat et al. 2018, Collivignarelli et al. 2018, Ebrahimi et al. 2018, Rahman et al. 2019), successful treatment of boat waste is promising, perhaps with the addition of pre-treatment steps. Research specifically dealing with variable COD loading could prove useful. It has been shown that increased COD loading can decrease treatment efficiencies (Hassani et al. 2014) and that variable loadings cause shifts in microbial populations on a daily scale (Frigon et al. 2002). Furthermore, treatment of high ammonia waste via biological nitrification treatment has been thoroughly researched. Nitrification is inhibited by high COD loadings due to slow reparation rates by nitrifying bacteria (Ling and Chen 2005, Carrera et al. 2004). However, research to mitigate this phenomenon by introducing a polyethylene glycol matrix (Xiangli et al. 2008) or a side-stream deammonification step (Rezania et al. 2015), for example, is encouraging.

Characterization and impact testing indicate boat waste is a highly variable waste stream and could have significant effects on treatment plant operations. As waste is diverted from natural waters to on-shore treatment facilities, operators will be faced with acceptance of this high

strength wastewater source. During this critical period, this local study could interest treatment plant operators and managers on a global scale.

## Conclusions and Recommendations

Based on the study presented in this report, boat waste could have a significant impact on treatment plant operations. High concentrations of ammonia, salinity, COD, phosphate, and solids were observed in boat waste compared to influent waste. Characteristics fluctuated between sample dates. Table 10 summarizes directions of observed trends of activated sludge behavior when in the presence of boat waste (often no clear trends were observed in several trials).

Table 10. Summary of Impact Testing Results.

Test	Direction of Observed Boat Waste Impacts
SOUR	Increase
COD Degradation	Decrease
Nitrogen Conversion	Modification of nitrifying organisms
SVI	Decrease
Foaming	Increase

Impact was highly dependent on sample location and date. More research is needed to understand relationships between activated sludge behavior and waste characteristics. Research should focus on:

- Boat waste impacts on activated sludge microorganisms
- Boat waste impacts on physical characteristics of activated sludge
- Identification of boat waste components contributing to increased foaming
- Sludge ability to degrade oxygen demand when in the presence of boat waste

- Boat waste impacts on nitrifying microorganisms
- Identification of chemical boat waste tracers

Furthermore, research dealing with impacts on anaerobic processes would be beneficial for Lopez Island Wastewater Treatment Plant as well as other anaerobic-treating facilities worldwide.

As activated sludge and boat waste has been shown to be heterogeneous in terms of sample date and location, activated sludge response to boat waste varies, posing a significant concern to treatment plant operators and workers. This variation in sludge response has been demonstrated in this study, with some trials demonstrating significant boat waste effects to sludge behavior while others caused no change. Another concern is boat waste is shock loaded to treatment plants following busy boating weekends, so loading could be significant. While loading at facilities such as Friday Harbor Wastewater Treatment Plant is currently low (always <1% total influent) sludge response should be closely monitored before, during, and after shock loading events.

An understanding of sludge and boat waste parameters in relation to sludge behavior can be a tool to help predict treatment response. Furthermore, sludge biology is expected to adapt to boat waste as higher concentrations and frequencies are introduced to treatment operations. This may help to mitigate unexpected responses. The introduction of small boat waste volumes to treatment operations provides an opportunity to increase understanding of boat waste impacts without concern for treatment viability. Additionally, this could provide an opportunity for microorganisms to acclimate to boat waste in a controlled manner. Lastly, adjustments to sludge

retention times may be needed in order to promote additional constituent removal introduced by high strength boat waste loadings.

## References

- Boonnorat, J., S. Techkarnjanaruk, R. Honda, S. Anghong, N. Boonapatcharoen, S. Muenmee and P. Prachanurak (2018). "Use of aged sludge bioaugmentation in two-stage activated sludge system to enhance the biodegradation of toxic organic compounds in high strength wastewater." *Chemosphere* 202: 208-217.
- Brown, C. A. (1982). *Treatability of recreational vehicle wastewater at highway rest areas*, Thesis (M.S.E.) University of Washington.
- California 2010. *Hazardous materials: Toxic chemicals: Sewage systems*. Health and Safety Code. Bill Number AB-1824.
- Carrera, J., T. Vicent and J. Lafuente (2004). "Effect of influent COD/N ratio on biological nitrogen removal (BNR) from high-strength ammonium industrial wastewater." *Process Biochemistry* 39(12): 2035-2041.
- Chen, Y., H. He, H. Liu, H. Li, G. Zeng, X. Xia and C. Yang (2018). "Effect of salinity on removal performance and activated sludge characteristics in sequencing batch reactors." *Bioresource Technology* 249: 890-899.
- Clark, B. D. (1967). *Houseboat Waste Characteristics and Treatment*. Corvallis, Oregon: U.S. Dept. of the Interior, Federal Water Pollution Control Administration, Northwest Region. Pacific Northwest Water Laboratory.
- Collivignarelli, M. C., A. Abba, G. Bertanza, M. Setti, G. Barbieri and A. Frattarola (2018). "Integrating novel (thermophilic aerobic membrane reactor-TAMR) and conventional

(conventional activated sludge-CAS) biological processes for the treatment of high strength aqueous wastes." *Bioresource Technology* 255: 213-219.

Du, B., J. M. Lofton, K. T. Peter, A. D. Gipe, C. A. James, J. K. McIntyre, N. L. Scholz, J. E.

Baker and E. P. Kolodziej (2017). "Development of suspect and non-target screening methods for detection of organic contaminants in highway runoff and fish tissue with high-resolution time-of-flight mass spectrometry." *Environmental Science: Processes Impacts* 19(9): 1185-1196.

Ebrahimi, M., H. Kazemi, S. A. Mirbagheri and T. D. Rockaway (2018). "Integrated Approach to Treatment of High-Strength Organic Wastewater by Using Anaerobic Rotating Biological Contactor." *Journal of Environmental Engineering* 144(2).

Elawwad, A. (2018). "Optimized biological nitrogen removal of high-strength ammonium wastewater by activated sludge modeling." *Journal of Water Reuse and Desalination* 8(3): 393-403.

Excel Analysis ToolPak, Microsoft Corporation: Excel 2016 Add-in.

Fatone, F., S. Di Fabio, D. Bolzonella and F. Cecchi (2011). "Fate of aromatic hydrocarbons in Italian municipal wastewater systems: An overview of wastewater treatment using conventional activated-sludge processes (CASP) and membrane bioreactors (MBRs)." *Water Research* 45(1): 93-104.

Frigon, D., D. B. Oerther, E. Morgenroth and L. Raskin (2002). "Oligonucleotide probe hybridization and modeling results suggest that populations consuming readily degradable substrate have high cellular RNA levels." *Water Science and Technology* 45(6): 115-126.

- Garland, C. W. (2009). Experiments in Physical Chemistry. Boston: McGraw-Hill Higher Education.
- Gerardi, M. H. (2002). Nitrification and Denitrification in the Activated Sludge Process. New York, New York: Wiley-Interscience.
- Gholami, M., A. Sabzali, E. Dehghanifard and R. Mirzaei (2011). "Comparative study of SMBR and extended aeration activated sludge processes in the treatment of high-strength wastewaters." *Desalination* 287(C).
- Hamza, R. A., O. T. Iorhemen and J. H. Tay (2016). "Advances in biological systems for the treatment of high-strength wastewater." *Journal of Water Process Engineering* 10: 128-142.
- Hassani, A. H., S. M. Borghei, H. Samadyar and B. Ghanbari (2014). "Utilization of moving bed biofilm reactor for industrial wastewater treatment containing ethylene glycol: kinetic and performance study." *Environmental Technology* 35(4): 499-507.
- Henze, M. (2008). *Biological Wastewater Treatment: Principles, Modelling and Design*. London: International Water Association Publications.
- Kiernan, K. E. (1982). An analysis of the potential impacts of recreational vehicle holding tank additives on biological waste treatment, Thesis (M.S.E.) University of Washington.
- Kim, S., P. A. Thiessen, E. E. Bolton, J. Chen, G. Fu, A. Gindulyte, L. Han, J. He, S. He, B. A. Shoemaker, J. Wang, B. Yu, J. Zhang and S. H. Bryant (2016). "PubChem Substance and Compound Databases." *Nucleic Acids Research* 44(D1): D1202-13.
- Lim, J.-M., D.-J. Park, C.-J. Kim, C. O. Jeon, S. S. Lee, L.-H. Xu and C.-L. Jaing (2008). "Reclassification of *Salegentibacter catena* Ying et al. 2007 as *Salinimicrobium catena* gen. nov., comb. nov. and description of *Salinimicrobium xinjiangense* sp. nov., a



- halophilic bacterium isolated from Xinjiang province in China." *International Journal of Systematic and Evolutionary Microbiology* 58(2): 438-442.
- Linarić, M., M. Markić and L. Sipos (2013). "High salinity wastewater treatment." *Water Science and Technology* 68(6): 1400.
- Ling, J. and S. Chen (2005). "Impact of organic carbon on nitrification performance of different biofilters." *Aquacultural Engineering* 33(2): 150-162.
- Lipczynska-Kochany, E. and J. Kochany (2008). "Respirometric studies on the impact of humic substances on the activated sludge treatment: Mitigation of an inhibitory effect caused by diesel oil." *Environmental Technology* 29(10): 1109-1118.
- Madigan, M., K. Bender, D. Buckley, M. Sattley and D. Stahl (2018). *Brock Biology of Microorganisms*. Boston, Pearson.
- Mannina, G., A. Cosenza, D. Di Trapani, M. Capodici and G. Viviani (2016). "Membrane bioreactors for treatment of saline wastewater contaminated by hydrocarbons (diesel fuel): An experimental pilot plant case study." *Chemical Engineering Journal* 291: 269-278.
- McCarthy, S. and T. Mohamedali. (2017). "Nitrogen in Puget Sound." Retrieved December 10, 2018, from <https://waecy.maps.arcgis.com/apps/MapSeries/index.html?appid=907dd54271f44aa0b1f08efd7efc4e30>.
- Montgomery, D. C. (2013). *Introduction to Linear Regression Analysis*. Hoboken, New Jersey: Wiley.
- Novak, J. T., C. R. McDaniel and S. C. Howard (1990). "The effect of boat holding tank chemicals on treatment plant performance." *Research Journal of the Water Pollution Control Federation* 62(3).

- Odum, E. P., J. T. Finn and E. H. Franz (1979). "Perturbation theory and the subsidy-stress gradient." *Bioscience* 29(6).
- Oregon State Marine Board (1995). *Effects of Boat Waste Disposal at Municipal Wastewater Treatment Facilities*.
- Ozaki, N., Y. Takamura, K. Kojima and T. Kindaichi (2015). "Loading and removal of PAHs in a wastewater treatment plant in a separated sewer system." *Water Research* 80: 337-345.
- Pernetti, M. and L. DiPalma (2005). "Experimental evaluation of inhibition effects of saline wastewater on activated sludge." *Environmental Technology* 26(6): 695-704.
- Personal Communication (2018). *Conversations with wastewater treatment engineers at King County, City of Tacoma, and City of Edmonds*.
- Pronk, M., J. Bassin, M. Kreuk, R. Kleerebezem and M. Loosdrecht (2014). "Evaluating the main and side effects of high salinity on aerobic granular sludge." *Applied Microbiology and Biotechnology* 98(3): 1339-1348.
- Rahman, A., H. De Clippeleir, W. Thomas, J. A. Jimenez, B. Wettg, A. Al-Omari, S. Murthy, R. Riffat and C. Butt (2019). "A-stage and high-rate contact-stabilization performance comparison for carbon and nutrient redirection from high-strength municipal wastewater." *Chemical Engineering Journal* 357: 737-749.
- Ramana, V. V., C. Sasikala and C. V. Ramana (2008). "Rhodobacter maris sp. nov., a phototrophic alphaproteobacterium isolated from a marine habitat of India." *International Journal of Systematic and Evolutionary Microbiology* 58(7): 1719-1722.
- Rezania, B., D. Mavinic and H. Kelly (2015). "Long-term performance of side-stream deammonification in a continuous flow granular-activated sludge process for nitrogen

- removal from high ammonium wastewater." *Water Science and Technology* 71(8): 1241-1248.
- Rice, E. W., L. Bridgewater, H. A. American Public, W. A. American Water and E. F. Water (2012). *Standard Methods for the Examination of Water and Wastewater*. Washington D.C.: American Public Health Association.
- Roberts, M., T. Mohamedali, B. Sackmann, K. Tarang and W. Long (2014). *Puget Sound and the Straits Dissolved Oxygen Assessment: Impacts of Current and Future Human Nitrogen Sources and Climate Change through 2070*.
- Robins, J. H. and A. C. Green (1974). "Development of On-Shore Treatment Systems for Sewage from Watercraft Waste Retention System." *Environmental Protection Technology Series EPA 670/2-74-056*.
- Schymanski, E. L., J. Jeon, R. Gulde, K. Fenner, M. Ruff, H. P. Singer and J. Hollender (2014). "Identifying small molecules via high resolution mass spectrometry: communicating confidence." *Environmental Science & Technology* 48(4): 2097.
- Sea Grant Washington (2016). "Pumpout Washington." 2018, from <https://pumpoutwashington.org/>. Accessed October 22, 2018.
- U.S. Fish and Wildlife Service. *The Clean Vessel Act*. US Department of the Interior. [https://nctc.fws.gov/Pubs9/cva\\_brochure.pdf](https://nctc.fws.gov/Pubs9/cva_brochure.pdf). Accessed December 7, 2018.
- Steliga, T., P. Jakubowicz and P. Kapusta (2015). "Changes in toxicity during treatment of wastewater from oil plant contaminated with petroleum hydrocarbons." *Journal of Chemical Technology & Biotechnology* 90(8): 1408-1418.
- Tchobanoglous, G., F. L. Burton and H. D. Stensel (2003). *Wastewater Engineering: Treatment and Reuse*. Boston: McGraw-Hill.

- Tchobanoglous, G., H. D. Stensel, R. Tsuchihashi, F. L. Burton, M. Abu-Orf, G. Bowden and W. Pfrang (2014). Wastewater Engineering: Treatment and Resource Recovery. New York, New York: McGraw-Hill Education.
- Tellez, G. T., N. Nirmalakhandan and J. L. Gardea-Torresdey (2002). "Performance evaluation of an activated sludge system for removing petroleum hydrocarbons from oilfield produced water." *Advances in Environmental Research* 6(4): 455-470.
- Thomas, W. (2002). Characterization of the inhibitory effects of recreational vehicle holding tank additive on an activated sludge system. R. J. Murphy, ProQuest Dissertations Publishing. University of South Florida.
- Tsioptsias, C., G. Lionta, A. Deligiannis and P. Samaras (2016). "Enhancement of the performance of a combined microalgae-activated sludge system for the treatment of high strength molasses wastewater." *Journal of Environmental Management* 183: 126-132.
- Walker, W., C. Haley, P. Bridgeman and S. Goldstein (1991). "Effects of deodorants on treatment of boat holding-tank waste." *Environmental Management* 15(3): 441-449.
- Watson, J. T. (2005). "Tennessee valley marina and campground wastewater characterization screening study." *Proceedings of the Water Environment Federation* 2005(12): 3685-3712.
- Washington State Department of Ecology, 1 (2017). Fact Sheet for NPDES Permit WA0030589. <https://fortress.wa.gov/ecy/paris/DownloadDocument.aspx?id=199776>
- Washington State Department of Ecology, 2 (2017). Fact Sheet for NPDES Permit No. WA0023582. <https://fortress.wa.gov/ecy/paris/DownloadDocument.aspx?id=214721>
- Washington State Parks (2018). "Boating Pumpout." from <https://parks.state.wa.us/657/Pumpout>. Accessed October 22, 2018.

- Williams, A. C. (2007). "Tennessee valley marina and campground wastewater characterization screening study follow-up report." *Proceedings of the Water Environment Federation* 2007(10): 7823-7837.
- Wishart D. S., Y. D. Feunang, A. Marcu, A. C. Guo, and K. Liang et al. (2018). "HMDB 4.0 — The Human Metabolome Database for 2018." *Nucleic Acids Research* 46(D1): D608-17.
- Xiangli, Q., Z. Zhenjia, C. Qingxuan and C. Yajie (2008). "Nitrification characteristics of PEG immobilized activated sludge at high ammonia and COD loading rates." *Desalination* 222(1-3): 340-347.
- Yang, C., W. Zhang, R. Liu, Q. Li, B. Li, S. Wang, C. Song, C. Qiao and A. Mulchandani (2011). "Phylogenetic diversity and metabolic potential of activated sludge microbial communities in full-scale wastewater treatment plants." *Environmental Science & Technology* 45(17): 7408.
- Zhang, Y., W.-L. Jiang, R.-X. Xu, G.-X. Wang and B. Xie (2017). "Effect of short-term salinity shock on unacclimated activated sludge with pressurized aeration in a sequencing batch reactor." *Separation and Purification Technology* 178: 200-206.

## Appendix A. San Juan Island Treatment Plant Process Flow Diagrams.

### Eastsound Wastewater Treatment Plant (Orcas Island)

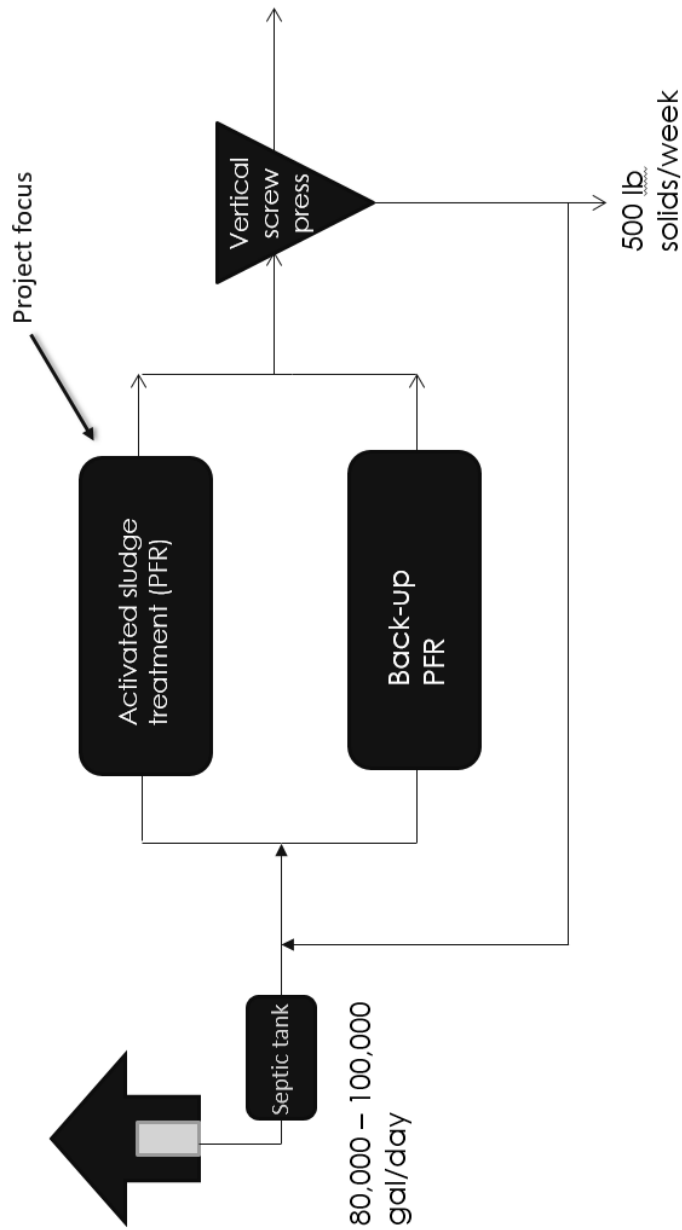

Friday Harbor Wastewater Treatment Plant (Washington State Department of Ecology, 2, 2017)

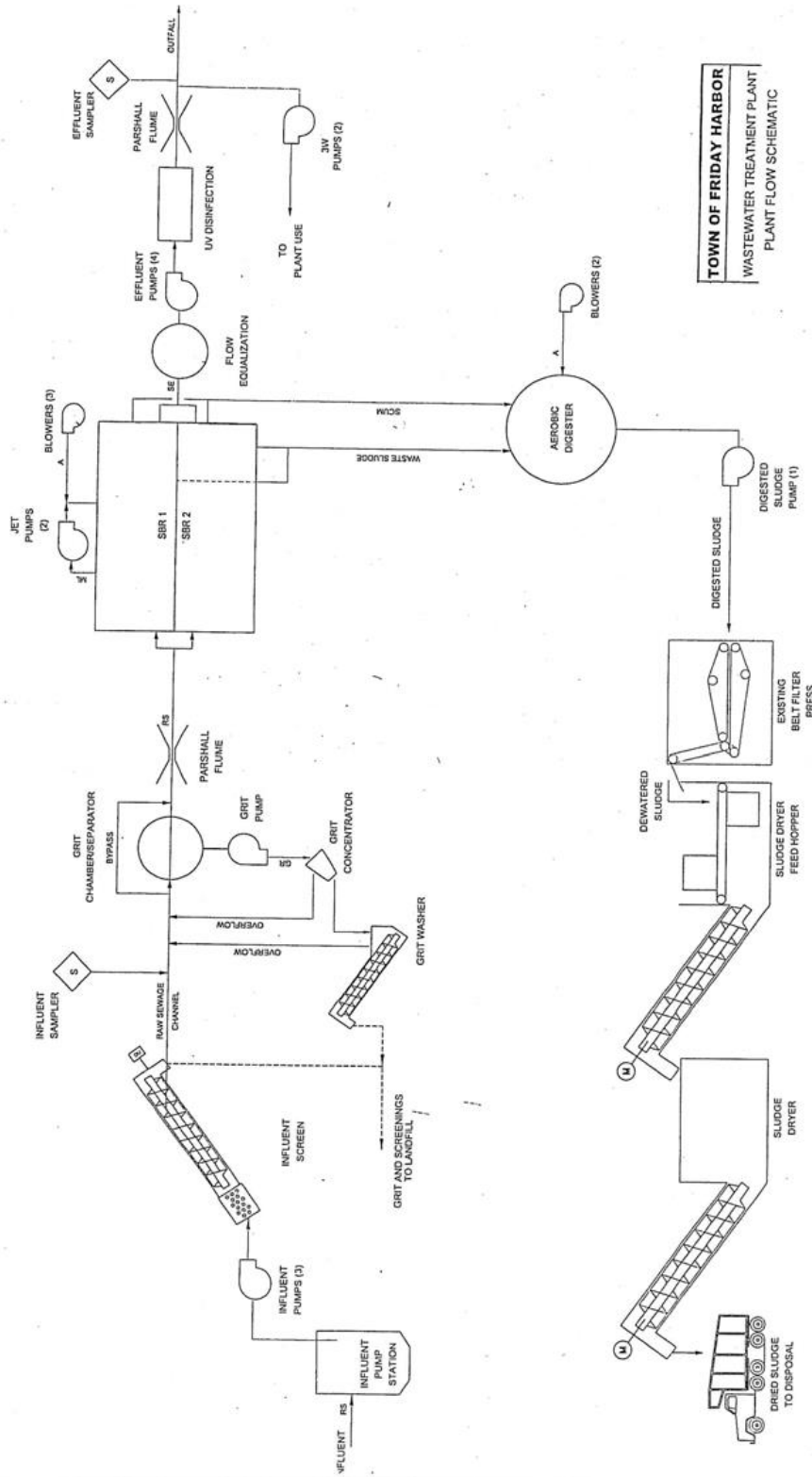

TOWN OF FRIDAY HARBOR  
WASTEWATER TREATMENT PLANT  
PLANT FLOW SCHEMATIC

Fisherman Bay Wastewater Treatment Plant (Lopez Island) (Washington State Department of Ecology, 1, 2017)

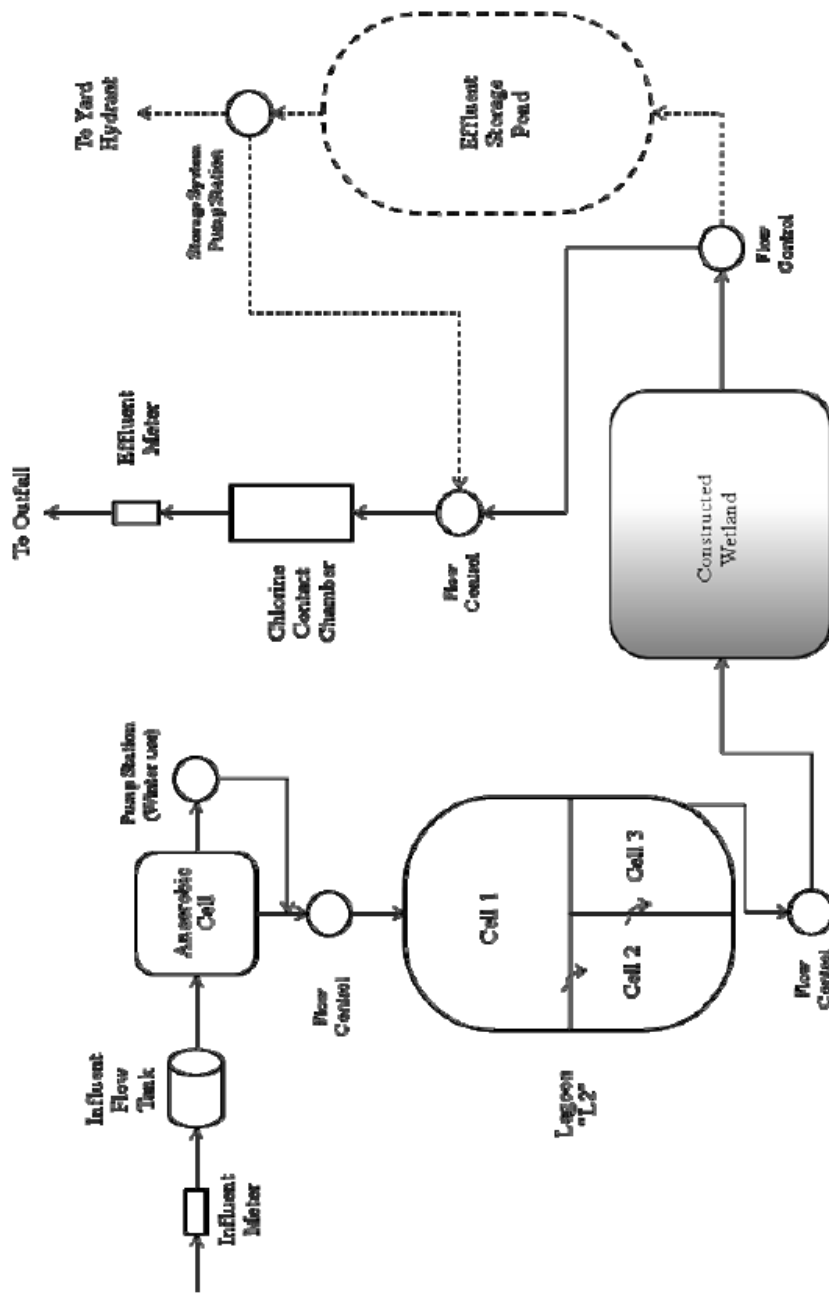



## Appendix B. Sampling Events and Tests Performed.

DATE	SAMPLE	CHAR	SVI	FOAM	SOUR	COD DEG	NITROGEN CONVERSION	CHEMICAL ANALYSIS
3/20/17	Eastsound AS					x		
3/21/17	Friday Harbor AS					x		
5/25/17	Portage Bay BW	x						
7/12/17	South Plant AS	x	x	x	x			
7/25/17	Portage Bay BW	x	x	x	x			
7/26/17	South Plant AS	x	x	x	x			
8/2/17	Golden Gardens SW	x	x	x	x			
8/7/17	South Plant AS		x	x	x			
8/13/17	Friday Harbor BW	x	x	x	x			
8/14/17	Friday Harbor AS	x				x		
8/14/17	Friday Harbor SW	x	x	x	x			
8/16/17	Friday Harbor AS	x	x	x	x			
10/15/17	Eastsound South AS	x				x		
10/15/17	Eastsound North AS	x				x		
10/17/17	Portage Bay BW	x				x		
11/30/17	Golden Gardens SW	x				x		
12/4/17	South Plant AS	x				x		
2/1/18	Portage Bay BW	x						
2/13/18	South Plant AS	x						
4/5/18	Portage Bay BW	x						x
5/8/18	South Plant AS							x
5/10/18	Portage Bay BW							x
5/15/18	South Plant AS							x
5/31/18	South Plant AS							x
6/19/18	South Plant AS							x
6/21/18	Portage Bay BW							x
6/26/18	South Plant AS							x
7/6/18	Friday Harbor SW	x	x	x	x	x		
7/7/18	Friday Harbor BW	x	x	x	x	x		
7/9/18	Eastsound North AS	x	x	x	x	x		

DATE	SAMPLE	CHAR	SVI	FOAM	SOUR	COD DEG	NITROGEN CONVERSION	CHEMICAL ANALYSIS
7/11/18	Friday Harbor AS	x	x	x	x	x		
7/16/18	Friday Harbor AS	x				x		
7/16/18	Friday Harbor SW	x						
8/1/18	South Plant AS						x	
8/2/18	Portage Bay BW			x			x	
8/7/18	West Point AS	x		x				
8/23/18	South Plant AS						x	
9/11/18	Portage Bay BW	x				x		
9/12/18	South Plant AS	x				x		
10/3/18	South Plant AS	x				x		
10/11/18	Portage Bay BW					x		
10/17/18	West Point AS					x		
11/6/18	Portage Bay BW					x		
11/14/18	Friday Harbor AS					x		
11/14/18	Eastsound North AS					x		

AS = Activated sludge; BW = Boat waste; SW = Seawater; RAS = Return activated sludge; Char, characterization testing; SVI, sludge volume index; SOUR, specific oxygen uptake rate; COD Deg, chemical oxygen demand degradation.

Activated sludge sample locations:

- King County South Treatment Plant
- King County West Point Treatment Plant
- Friday Harbor Wastewater Treatment Plant
- Eastsound Wastewater Treatment Plant (contains a “North” and “South” treatment train)

Boat waste sample locations:

- Friday Harbor Marina - Port of Friday Harbor
- Boat Street Marina at Portage Bay (Seattle) - Terry and Sons Mobile Pumpout Service

Seawater sample locations:

- Golden Gardens Park (Seattle)
- University of Washington Friday Harbor Laboratories

## Appendix C. Oxygen Uptake Measurements for SOUR Calculations.

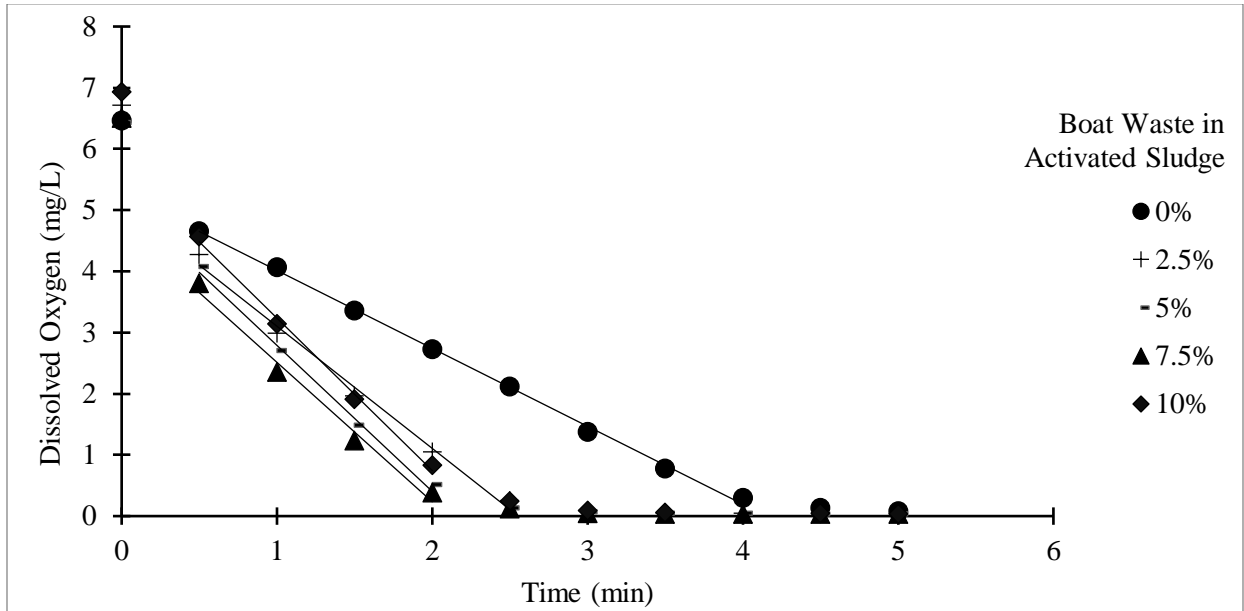

Figure C1. Oxygen Uptake in South Plant activated sludge and boat waste solutions on 7-28-17.

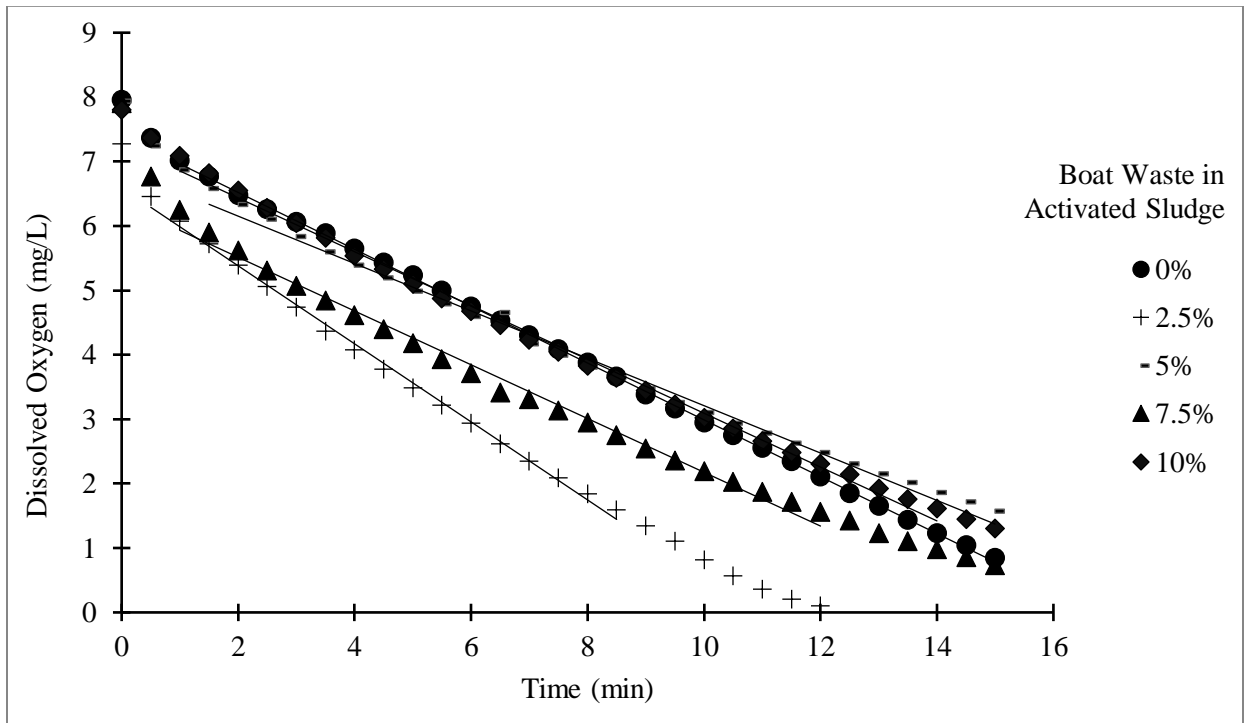

Figure C2. Oxygen Uptake in Friday Harbor activated sludge and boat waste solutions on 8-14-17.

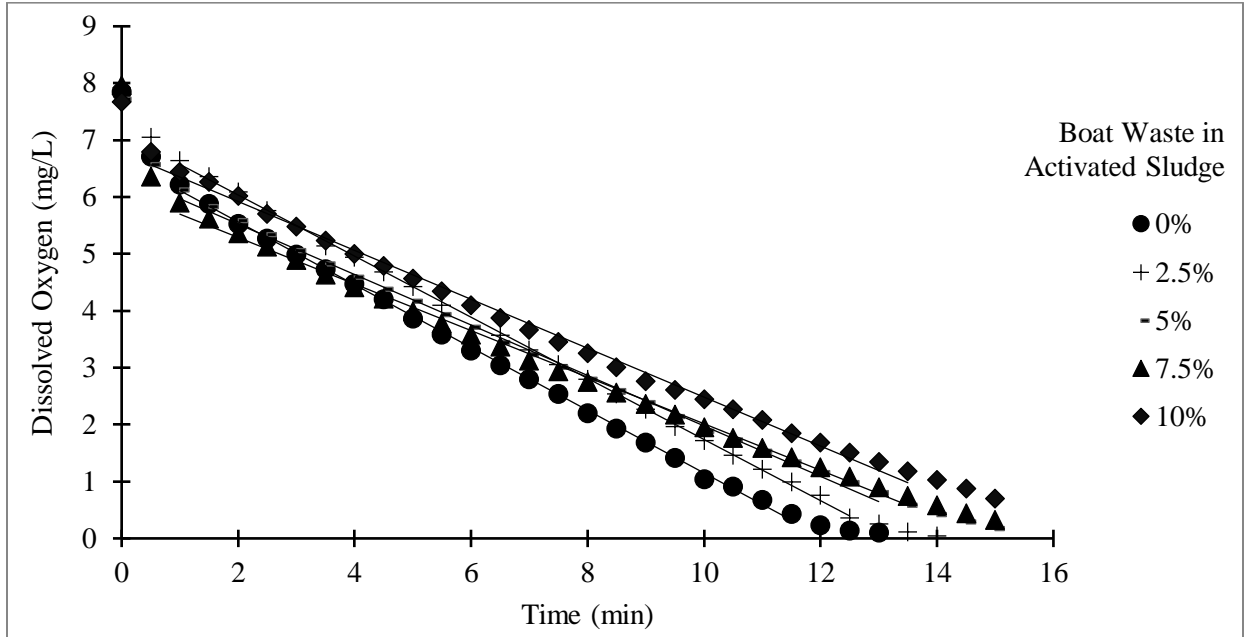

Figure C3. Oxygen Uptake in Friday Harbor activated sludge and boat waste solutions on 8-17-17.

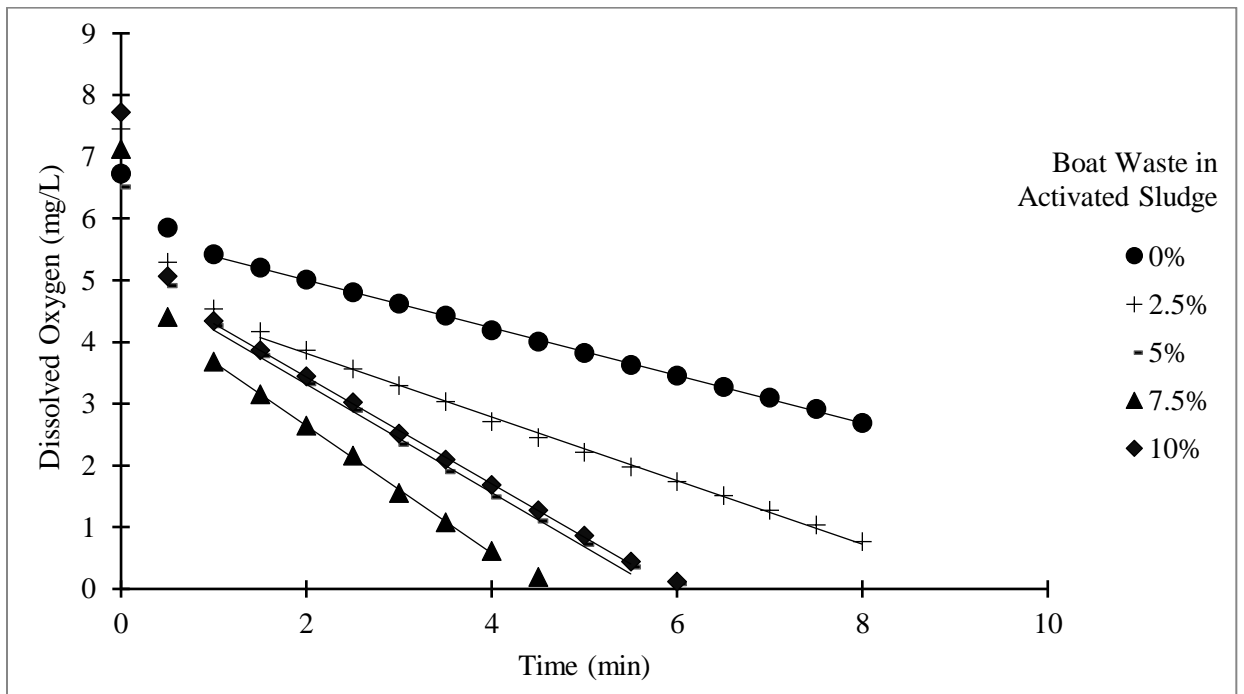

Figure C4. Oxygen Uptake in Friday Harbor activated sludge and boat waste solutions on 7-12-18.

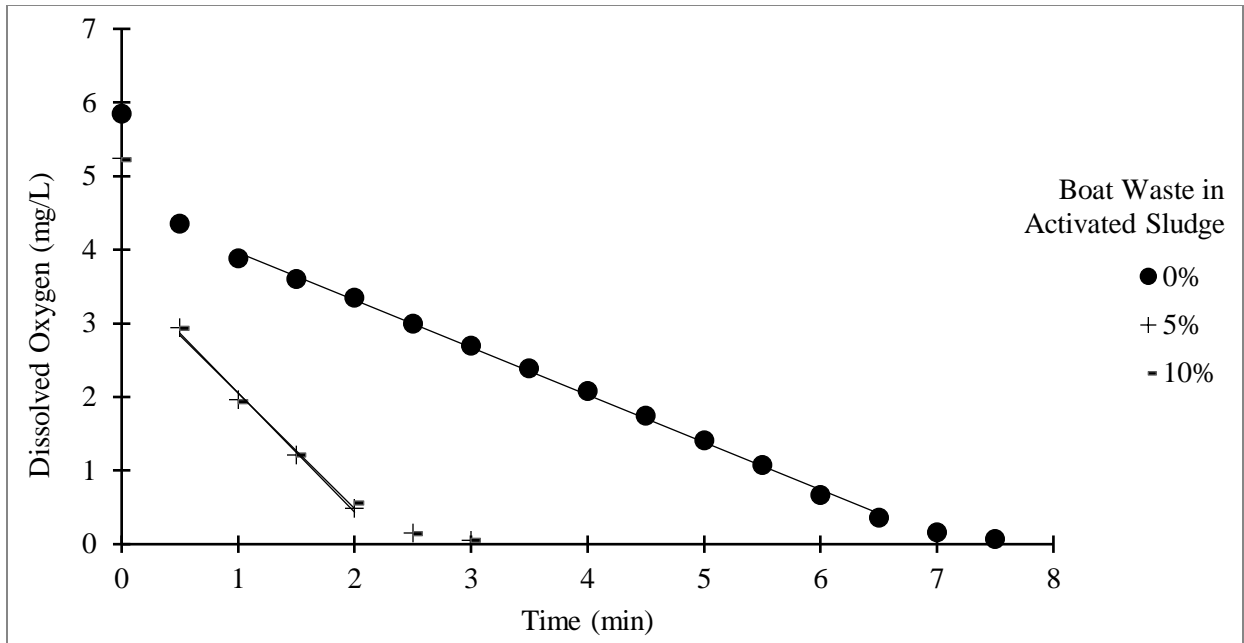

Figure C5. Oxygen Uptake in Eastsound (South) activated sludge and boat waste solutions on 10-17-17.

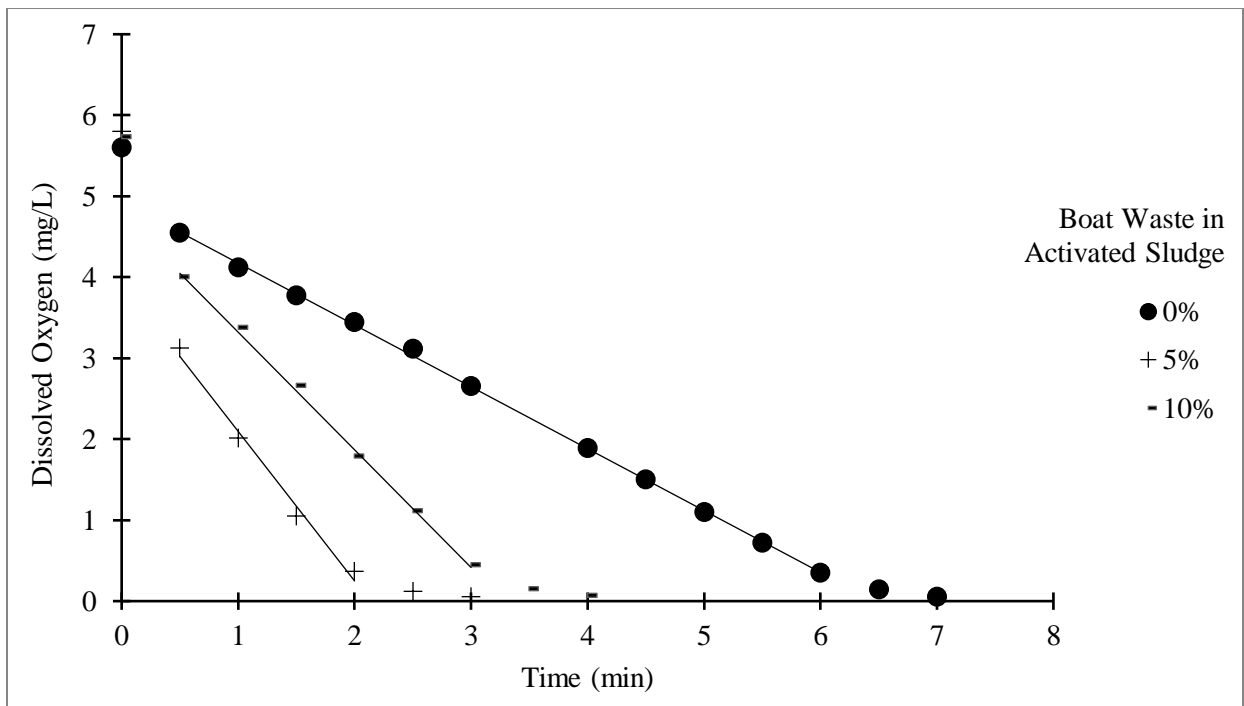

Figure C6. Oxygen Uptake in Eastsound (North) activated sludge and boat waste solutions on 10-17-17.

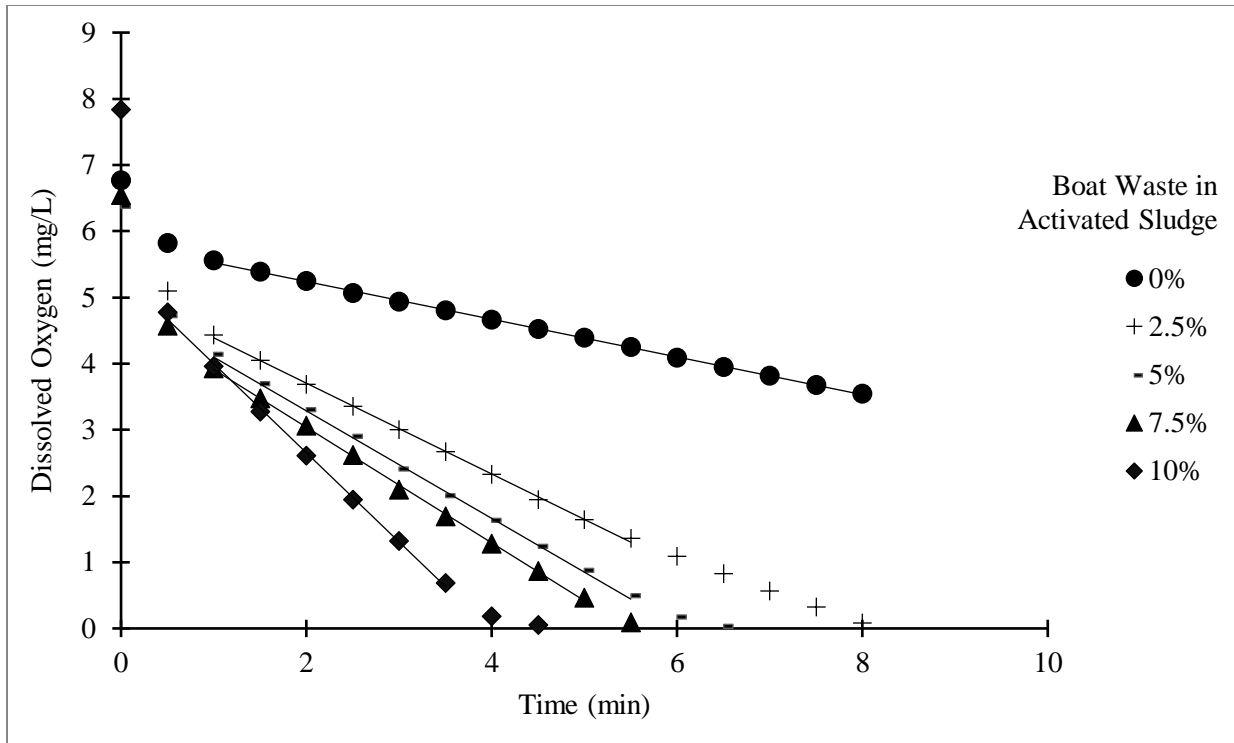
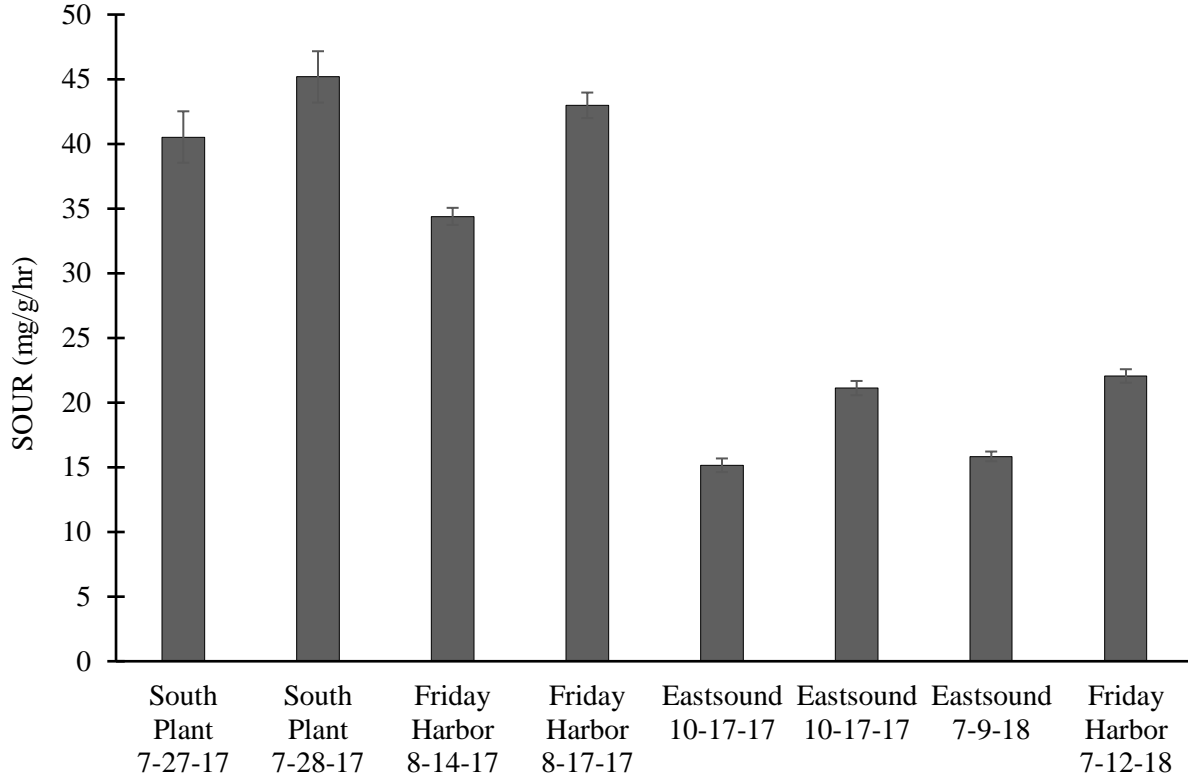

Figure C7. Oxygen Uptake in Eastsound (North) activated sludge and boat waste solutions on 7-9-18.

**Appendix D. Non-Normalized SOUR and SVI Results and Impacts of Boat Waste Components on Activated Sludge Behavior.**



Wastewater Treatment Plant Facility Activated Sludge and Sample Date

Figure D1. Specific Oxygen Uptake Rates measured in activated sludge. Samples from 2018 were diluted 1:1 with tap water because initial oxygen uptake was too fast to obtain a linear trend.

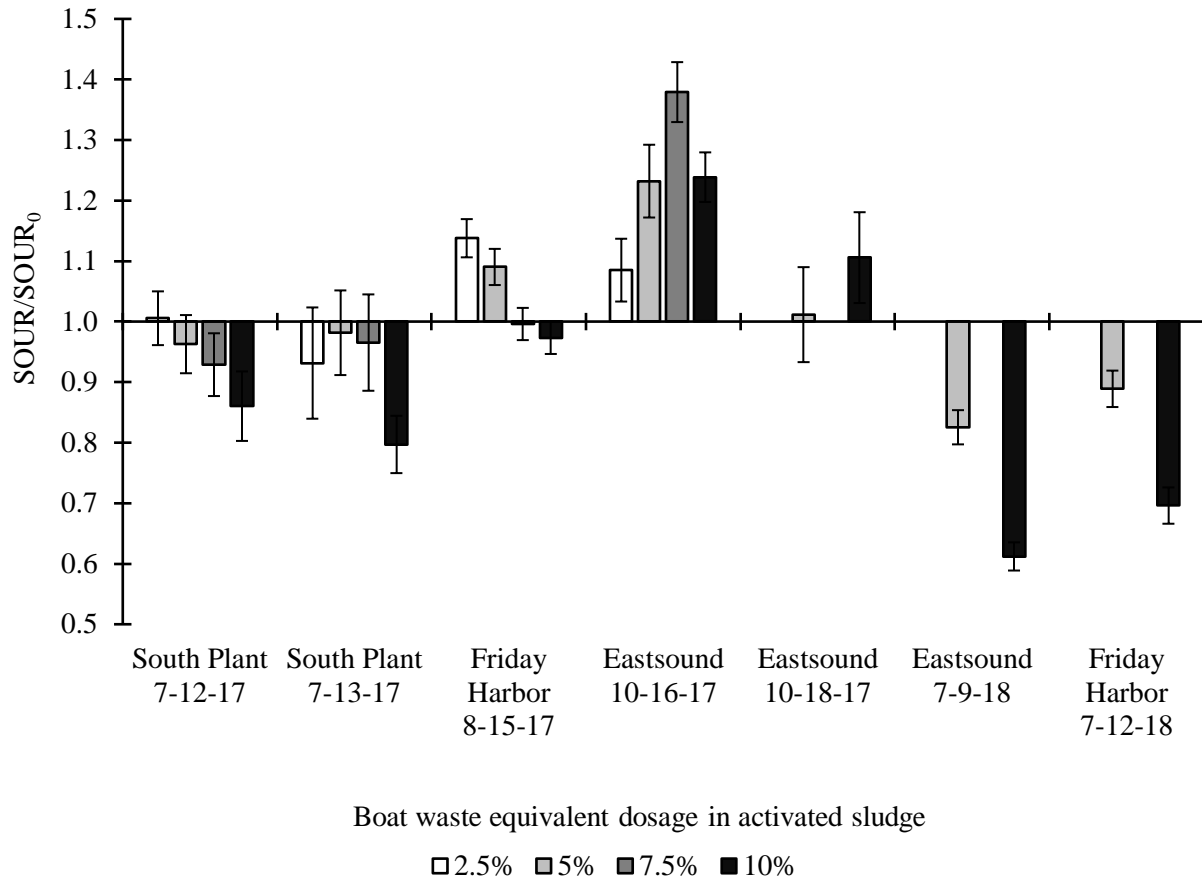

Figure D2. Influence of Thetford Marine Aqua-Kem Holding Tank Deodorant on oxygen uptake in activated sludge.



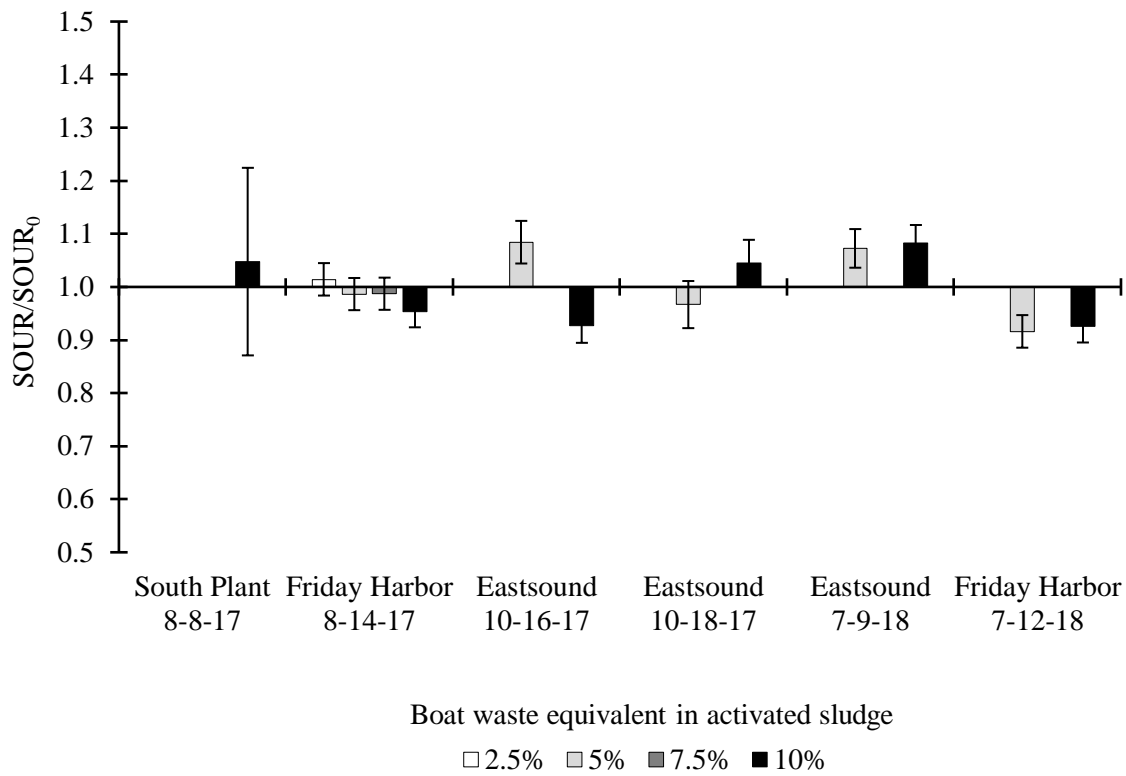

Figure D3. Impact of seawater on specific oxygen uptake rate in activated sludge. Volumes of seawater added were ½ the boat waste equivalent (for example 10% boat waste equivalent is a 5% seawater solution).

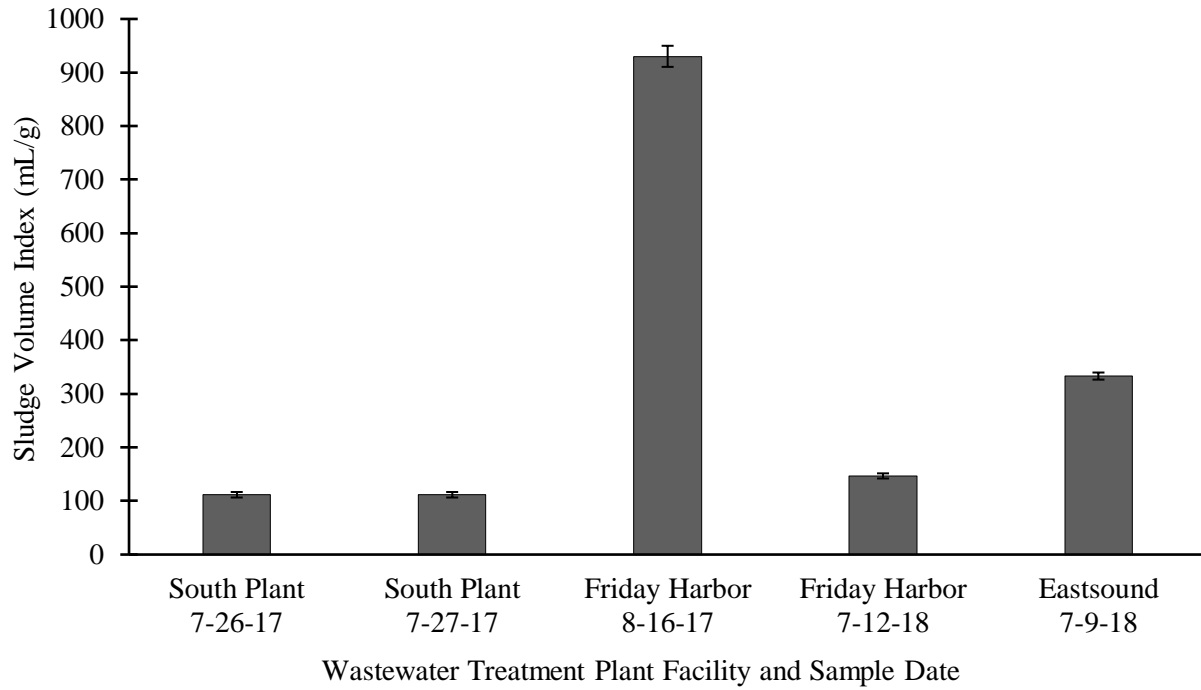

Figure D4. Sludge volume index (SVI) measured for activated sludge collected from three different wastewater treatment facilities. Error bars represent glassware limitations and TSS confidence.

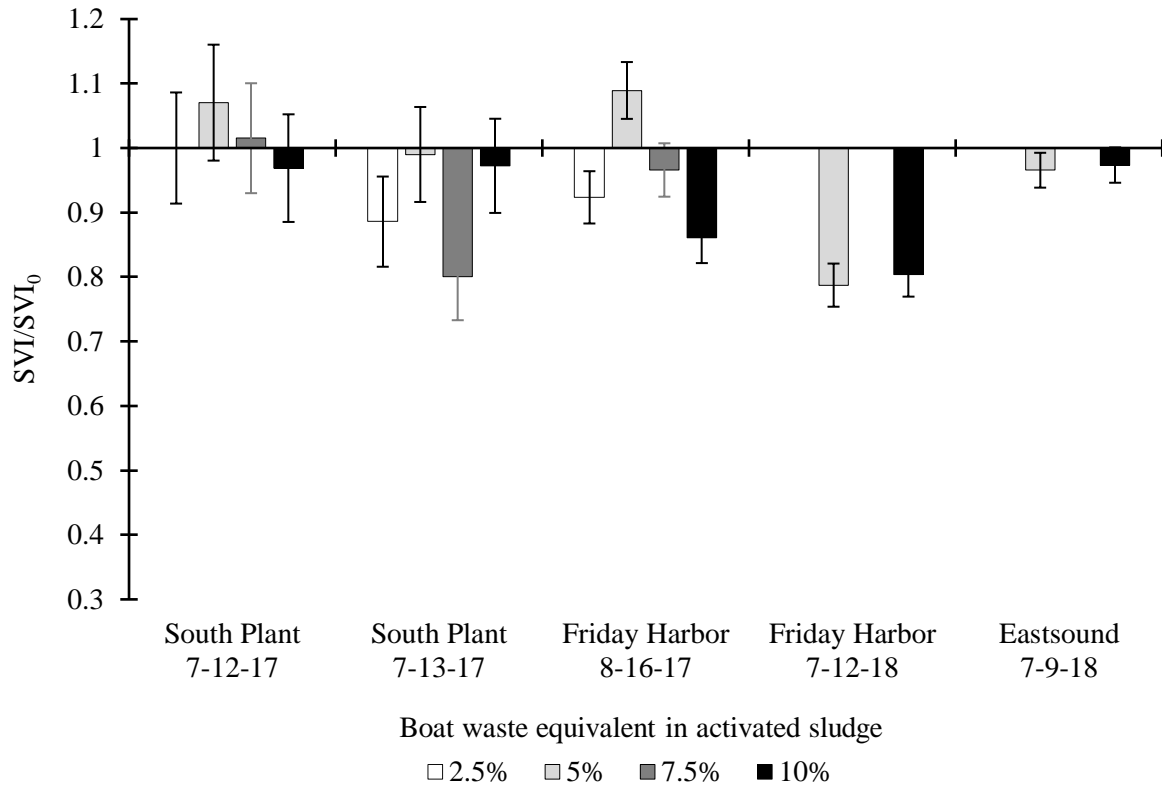

Figure D5. Influence of boat waste tank additive (Aqua-Kem Deodorant) on activated sludge settleability. Volumes of additive were diluted in water according the manufacturer’s recommendations for proportional additions to boat tanks to create a “boat waste equivalent value.” Error bars show the glassware measuring error as defined by the manufacturer and the measured deviation of total suspended solids replicates.

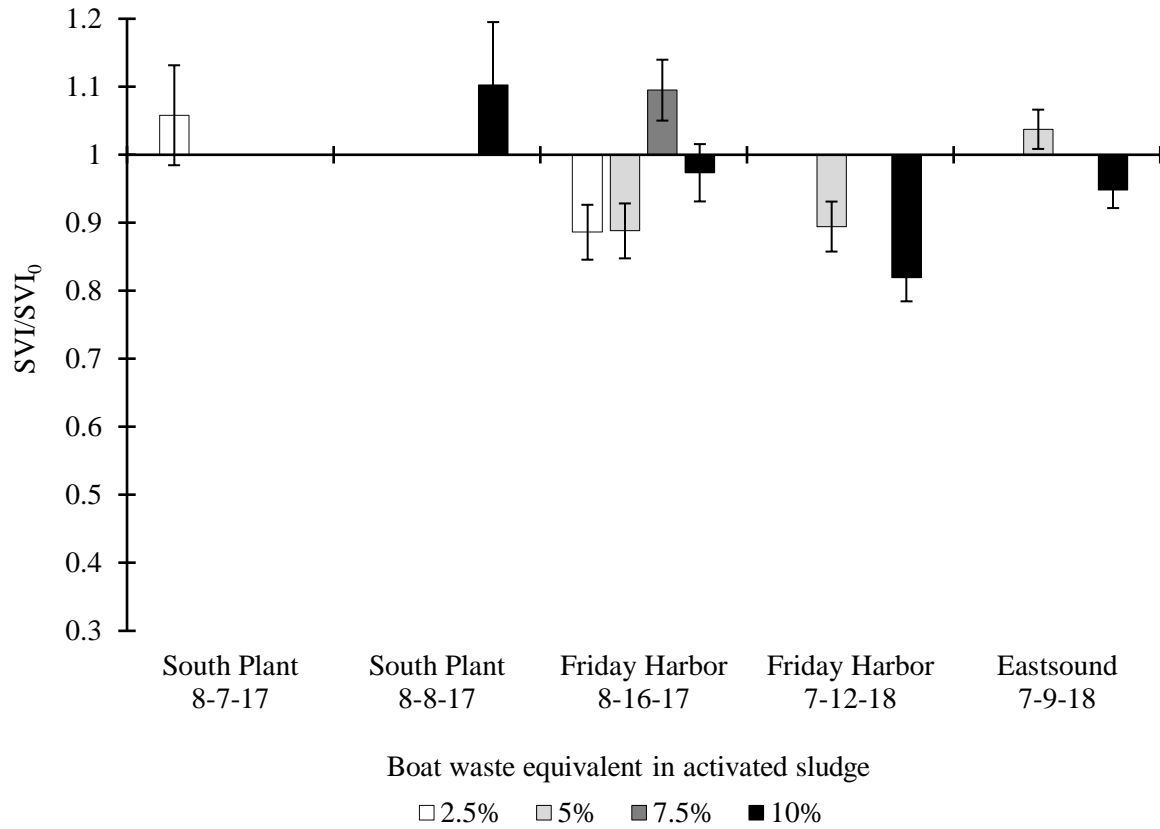

Figure D6. Influence of salinity on settleability of activated sludge. Volumes of seawater added were ½ the boat waste equivalent (for example 10% boat waste equivalent is a 5% seawater solution).

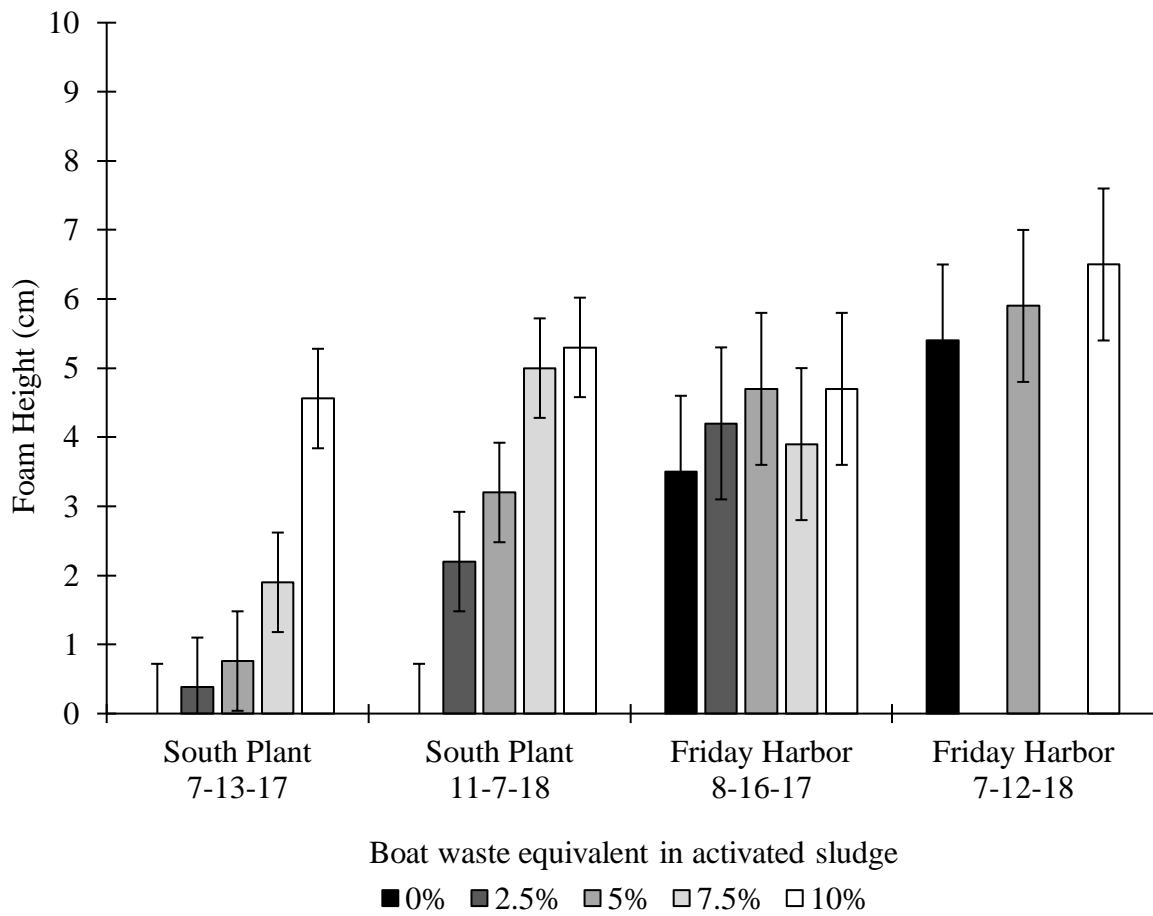

Figure D7. Influence of Thetford Marine Aqua-Kem Deodorant on foaming in activated sludge.

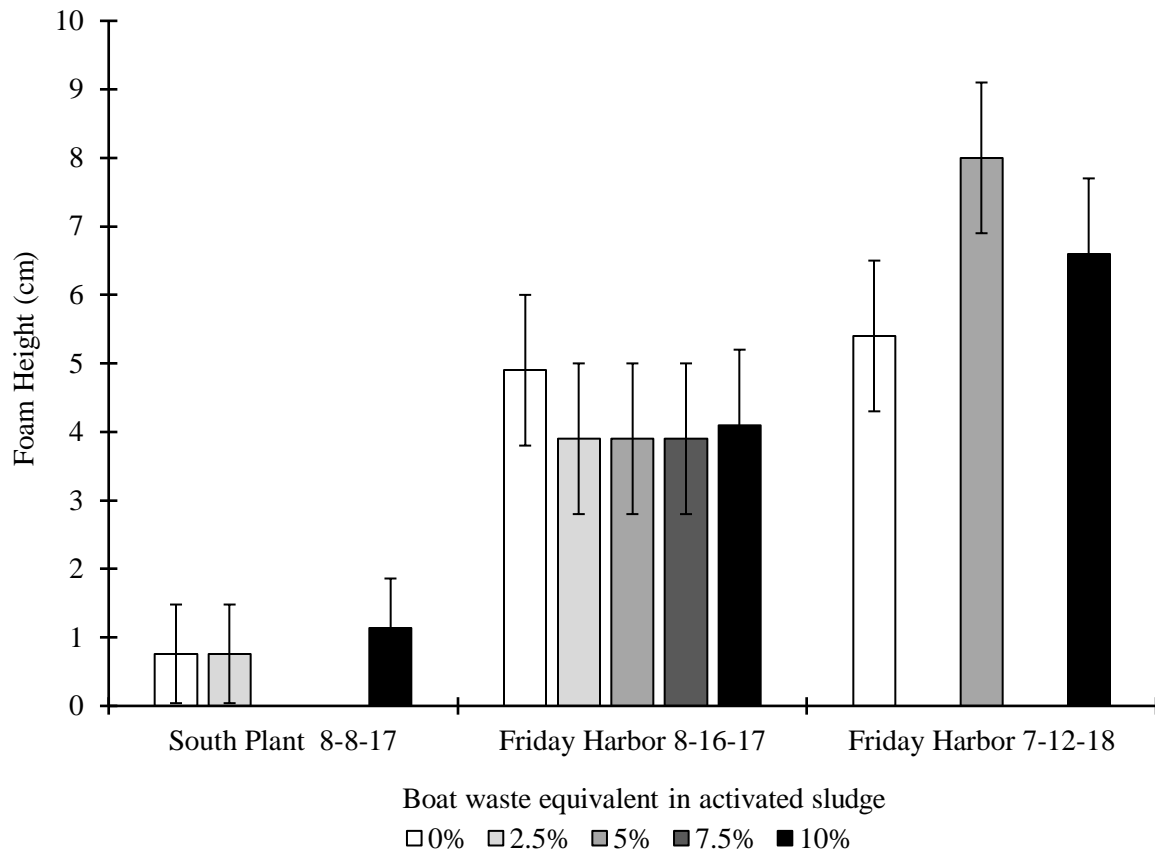

Figure D8. Influence of seawater on foaming in activated sludge. Volumes of seawater added were ½ the boat waste equivalent (for example 10% boat waste equivalent is a 5% seawater solution).